

Gas & Electric STOVES





Stockton 5 Gas Balanced Flue with log-effect fire

A warm welcome

Nothing creates an inviting atmosphere quite like a Gazco stove. The centrepiece of any home, a Gazco stove adds warmth and character to a room or living space – even if you don't have a chimney! Whether you want to achieve a minimalist, contemporary look, or have your heart set on a more traditional stove, this brochure will help you make the perfect choice, whatever your style or budget.

From the highly efficient contemporary Gas Riva Vision range with all its style and elegance, to the stunning cast iron detail on a more traditional Huntingdon stove, these innovative designs will appeal to any modern or traditional home.



Studio 1 Freestanding with White front, matching plinth and White Stone fuel bed.



There is also a range of highly realistic, electric log-effect stoves featuring Gazco's VeriFlame™ technology. These electric stoves open up new possibilities such as conservatories, kitchens, dining rooms and bedrooms for you to have the warmth and character of a Gazco stove in your home.



Contents

Relax – it's a Gazco stove 4

Flue and Fuel Types 8 - 9

Traditional Styles

Gas and Electric Marlborough 10 - 13

Gas and Electric Stockton 14 - 19

Gas and Electric Huntingdon 20 - 27

Gas and Electric Ashdon 28 - 33

Contemporary Styles

Gas and Electric Steel Manhattan 34 - 37

Gas Riva Vision 38 - 39

Gas Riva Vision Large 40 - 41

Electric Riva Vision 42 - 43

Gas Riva2 F670 Glass 44 - 45

Gas Riva2 F670 Steel 46 - 47

Studio Freestanding Gas 48 - 49

Additional Information 50 - 51

Stove Selector 52 - 53

Technical Information 54 - 66





Relax – it's a Gazco stove

When you choose Gazco, quality and innovative technology are assured. From traditional models to contemporary designs, Gazco is committed to creating the ultimate flame-effect gas and electric stoves.



Our research and development laboratories are amongst the most advanced in the world, ensuring that the very latest innovations are incorporated into our appliances.

Gazco is an ISO9001 accredited company. Our rigorous quality control system ensures that all our appliances comply with British safety standards as well as stringent European regulations. All fires in this brochure are CE marked. This means they have been independently tested to exacting European standards for safety as well as both heating efficiency and emissions.



Warranty

Your Gazco Expert Retailer will provide you with a Two Year Warranty for your new gas or electric stove. The warranty for gas stoves can be extended to a period of five years by registering your stove with Gazco. Please note, these warranties exclude certain consumable parts. Stoves purchased outside of Gazco's Expert Retailer Network will carry a standard 1 Year non-extendable Warranty. Full warranty terms & conditions are available to view at www.gazco.com



Selecting Your Stove

Before you choose your new stove you will need to know what type of chimney (if you have one) or flue you have. Please turn to pages 8 - 9 to identify your chimney or flue type.



Expert Retailer Network

We take great care to ensure that our stoves are designed, tested and manufactured to the highest possible quality and safety standards. We are just as concerned to make certain that they are sold and installed correctly so that you enjoy years of pleasure from your purchase.

Accordingly, you will find our products are only available from experienced, independent retailers who will be happy to show you a selection of models locally in their showrooms, often fully operational. These independent retailers will discuss your individual requirements both technical (such as sizing the heat output to your room and advising on your flue type) and design, and ensure that you select the most appropriate product for your home. These retailers will also be able to advise on, or assist with, the installation process as well as help provide any after-sales support and servicing your appliance may require in the future.

Whilst we encourage our retailers to promote fireplace products and their outlets via the internet, we do not believe suitable levels of customer care and satisfaction can be obtained from purchasing the product only online and we would strongly recommend that you consider this when undertaking your research and making a purchasing decision. Furthermore, please be aware that we do not offer technical support (beyond our statutory responsibilities) to products bought via nationwide online sales, where this support would normally be offered by one of our qualified, independent retailers.

Furthermore, Gazco fires and stoves purchased from within our Expert Retailer Network will have the additional benefit of a greatly extended warranty period, subject to terms and conditions. Full details can be found at www.gazco.com



What's your type?

Before you select your stove, your local Gazco retailer will need to make sure it's suitable for your home. Firstly, you need to know what fuel you will be running. Secondly, you will need to be aware of what type of chimney or flue you have. If you do not have a chimney then don't worry, Gazco have models developed to suit your home too! To assist you in selecting the right stove for your home, a general guide to which models can be installed with the various flue types is given on each page.

Fuel - Gas or Electric?

The majority of our stoves are available in either gas or electric versions. All the electric models run on a standard 13amp plug and have no need for a chimney.

Which Gas type....

All Gazco gas stoves in this brochure can be specified for use with either Natural Gas or LPG. Natural Gas is provided through mains pipelines, whilst LPG is usually supplied to homes in rural areas from a tank in the garden or gas bottles.

Your Home...

The type of chimney or flue you have usually dictates your choice of stove. To help you understand which stoves are suitable for your home, please use the information and pictures shown opposite to identify your chimney. Don't worry, if you don't have a chimney though, you can still find the perfect stove for your home. Once you have identified your chimney(or confirmed you do not have one), take note of the symbol that represents this, as this has been used throughout the brochure to represent the stoves that are suitable for installation in your home.

Conventional Flue

Conventional flue systems are easily recognisable as either a conventional brick or stone chimney, pre-fabricated or pre-cast chimney system. Should your home have none of these at present, it is usually possible to have a pre-fabricated system installed in your home if required.



Brick or Stone Chimney
(Class 1) **1**

The chimney stack rises well above the roofline and is topped by a traditional chimney pot or gas terminal. This type of chimney relies on the natural circulation of heated air to expel the products of combustion up your chimney.



Pre-Fabricated Flues
(Class 1 & 2) **2**

You will see a metal flue cowl on your roof. Some are all metal whilst others may terminate through a short rectangular pot (but without a chimney stack). These flues create the same circulation of heated air as a brick or stone chimney.



Pre-Cast flues
(Class 2) **3**

Many modern homes have been built with such flues. You can readily identify them by either a metal flue cowl or a raised ridge terminal on your roof. Again, the natural circulation of heated air expels the products of combustion. This option is only available on the small stoves.

Balanced Flue

Balanced flues work in conjunction with Gazco's Glass Fronted gas stoves. The appliance is completely sealed from the room into which it is installed (so there are no draughts and heating efficiency is increased) and a twin-wall pipe vents directly to an outside wall.



Balanced Flue
(No chimney required) **BF**



Air for combustion is drawn in through the outer pipe whilst the inner pipe removes the combustion gases to the exterior of the property. Depending on the stove selected, the twin-walled pipe may exit horizontally through an external wall or vertically through the roof. Gazco offers a comprehensive range of balanced flue system components. Please refer to our dedicated Concentric Flue System brochure which can be requested from your retailer or viewed online at www.gazco.com.



Powered Flue
(No chimney required) **PF**

A powered flue uses an extractor unit mounted to vent the combustion gases directly outside. This means that your stove does not have to be installed against an external wall, so it can be located in more rooms around your home. A mains electricity supply is needed to operate this system.



Electric Stoves
(No chimney required) **⚡**

Gazco produce an excellent selection of electric Marlborough, Stockton, Huntingdon 30, Clarendon, Ashdon, Steel Manhattan and Riva Vision stoves which do not, of course, require a chimney or flue of any kind.

No Air Vent required (UK)

All stoves shown with this symbol, boast the advantage of not normally requiring an air vent* where the air permeability is greater than 5.0m³/hr/m². Please discuss this in full with your local Gazco retailer.

*Requirements in the Republic Of Ireland are different.



Gas Marlborough



Small Gas Marlborough balanced flue with log-effect fire



Large Gas Marlborough conventional flue with coal-effect fire

Country or city, traditional or contemporary, the innovative Gas Marlborough has the flexibility to suit your lifestyle and your décor. It is available in three sizes and each has an extensive window area to allow you to enjoy the dancing flames and warm ambience of the coal or log-effect fires to the full.

Operation is simplicity itself too. There's an easy ignition and a manual control to adjust the flame height and heat output. Choose Gazco's Command upgradeable remote control and you can adjust the flames and heat from your armchair. Alternatively, opt for the deluxe Programmable upgradeable remote control to set the stove to switch itself on and off and heat the room to the temperature you select.

See page 5 for additional image.

Colour Choice

Matt Black

Heat Output

S: 1.95 - 3.60kW

M: 2.50 - 5.28kW

L: 3.10 - 7.25kW

Efficiency

Conventional flue 78%

Balanced flue 82%

Fuel Bed

Coals

Logs

Command Controls

Manual

Standard upgradeable

Programmable Thermostatic upgradeable

Chimney Types

1 2 3 BF PF

(please see pages 8-9)

Efficiency figures given are based upon the maximum heat output achieved for these models.

For complete model choices, specifications and additional information please see pages 50-54 and 56.

Electric Marlborough



Featuring the same distinctive styling as the Gas Marlborough, the two electric versions offer you an amazingly realistic log-effect fire at the touch of a button. At its heart is Gazco's unique VeriFlame™ technology which allows you to choose from two heat settings that can both be thermostatically controlled; three flame brightness levels, plus the additional option for a blue flame effect on the high setting so you can match your mood exactly. Furthermore, the beautiful flames can be enjoyed without heat, allowing you to enjoy your fire all year round.

The Electric Marlborough simply plugs into a 13amp socket, so is particularly suited for conservatories, bedrooms or home study, in fact any room without a chimney.

* The thermostat is controlled manually from the stove.

Colour Choice

Matt Black

Efficiency

99.8%

Command Controls

Remote as standard

Heat Output

S: 1.00 - 2.00kW

M: 1.00 - 2.00kW

Fuel Bed

Logs

Chimney Types



No chimney required

Efficiency figures given are based upon the maximum heat output achieved for these models.

For complete model choices, specifications and additional information please see pages 50-51 and 55-56







Gas Stockton



Small Gas Stockton balanced flue with log-effect fire

Using cast iron for the door and heavy gauge steel for the body, Gas Stockton stoves combine simple, understated lines with Gazco's latest living flame technology.

This means you can enjoy an unrivalled coal or log-effect fire together with a heating performance that will keep your room really cosy on those cold winter evenings. In fact, you won't even have to move from your chair if you opt for one of our remote controls!

Colour Choice

Matt Black

Heat Output

S: 1.95 - 3.60kW 

M: 2.50 - 5.28kW 

Efficiency

Conventional flue 78%

Balanced flue 82%

Fuel Bed

Coals

Logs

Command Controls

Manual

Standard upgradeable

Programmable Thermostatic upgradeable

Chimney Types

(please see pages 8-9)

Efficiency figures given are based upon the maximum heat output achieved for these models.

For complete model choices, specifications and additional information please see pages 50-54 and 56



Gas Stockton 5



Gas Stockton 5* conventional flue with coal-effect fire

With authentic multi-fuel stove styling, right down to the hinged door with handle, the Gas Stockton 5 is conveniently sized between the small and medium models featured on the previous page. So you have even more opportunity to suit your needs – and to enjoy all the enchantment of a real coal or log-effect fire.

Please see page 45 for additional image.

Colour Choice

Matt Black

Fuel Bed

Logs

Coals

Heat Output

1.95 - 3.40kW 

Efficiency

Conventional flue 73%

Balanced flue 80%

Command Controls

Manual

Standard upgradeable

Programmable Thermostatic upgradeable

Chimney Types

1 2 BF

(please see pages 8-9)

**Please note this is a viable installation in stone, but not suitable for combustible materials.*

Efficiency figures given are based upon the maximum heat output achieved for these models.

For complete model choices, specifications and additional information please see pages 50-54 and 56

Electric Stockton



Electric Stockton Medium in Matt Black



Electric Stockton Small in Matt Black

Using the same cast iron door and heavy gauge steel body as the Gas Stocktons, the electric version combines the classic looks of a woodburning stove with the ease of Gazco's unique VeriFlame™ technology. This means you can enjoy two heat settings that can both be thermostatically controlled; three flame intensity levels, plus the additional option for a blue flame effect on the high setting to create a remarkably authentic log-effect fire - a superb focal point for any room. Choose from the Stockton Small, Stockton 5 or the Stockton Medium.

Colour Choice

Matt Black

Heat Output

S: 1.00 - 2.00kW 

5: 1.00 - 2.00kW 

M: 1.00 - 2.00kW 

Efficiency

99.8%

Fuel Bed

Logs

Command Controls

Remote as standard

Chimney Types



No chimney required

Efficiency figures given are based upon the maximum heat output achieved for these models.

For complete model choices, specifications and additional information please see pages 50-51 and 55-56





Gas Huntingdon 20



Gas Huntingdon 20 with Tracery Door in Matt Black

The compact Gas Huntingdon 20's proportions make it perfect for British fireplace openings, whilst its highly efficient 2.6kW heat output easily creates a warming atmosphere in standard sized rooms. Producing dancing flames over a realistic log fuel bed, this stove is offered with Standard and Programmable Thermostatic remote controls, providing real fire ambience at the touch of a button.

Presented in either Matt Black, Matt Ivory or Ivory enamel finishes, the Huntingdon 20 lets you choose a colour that best suits your home. Further expanding the styling options available, this elegant stove is also offered in both clear door and tracery versions.

Colour Choice

Matt Black
Matt Ivory
Ivory

Heat Output

1.64 - 2.62kW 

Efficiency

Conventional flue 75%
Balanced flue 82%

Fuel Bed

Logs

Command Controls

Manual
Standard upgradeable
Programmable Thermostatic upgradeable

Chimney Types

(please see pages 8-9)

*Efficiency figures given are based upon the maximum heat output achieved for these models.
For complete model choices, specifications and additional information please see pages 50-54 and 57*



Gas Huntingdon 30



Gas Huntingdon 30 conventional flue with tracery door and coal-effect in Matt Black



Gas Huntingdon 30 with clear door and log-effect in Ivory enamel

The Gas Huntingdon 30 combines refined styling with efficient heating technology. Available in Matt Black, Matt Ivory and Ivory enamel finishes, the beautiful flame picture gives great warmth and style to any interior. The Huntingdon 30 is available with either elegant tracery or as a clear door version for stylistic versatility.

Choose from either realistic coal or log fuel effects, the latter sporting a glowing ember bed for the ultimate real fire ambiance. Both fuel effects are available in conventional flue versions, whilst the log effect is also available in a balanced flue model. The Gas Huntingdon comes with manual control or, for total ease and convenience, upgrade to one of Gazco's command remote controls.

Also see images on page 58, 67 and front cover.

Colour Choice

Matt Black
Matt Ivory
Ivory

Heat Output

1.90 - 3.50kW 

Efficiency

Conventional flue 75%
Balanced flue 81%

Fuel Bed

Logs
Coals

Command Controls

Manual
Standard upgradeable
Programmable Thermostatic upgradeable

Chimney Types

  
(please see pages 8-9)

Efficiency figures given are based upon the maximum heat output achieved for these models.
For complete model choices, specifications and additional information please see pages 50-54 and 58



Gas Huntingdon 40



Gas Huntingdon 40 with tracery door in Matt Ivory.
Shown with Sandringham Limestone Mantel

The largest model in the Huntingdon range, the Gas Huntingdon 40 is perfectly at home in big open fireplaces or spacious interiors. With a powerful heat output of 5.4kW, it can quickly create a warming atmosphere whilst still maintaining an exceptional efficiency up to 84%, thanks to its cutting edge gas stove technology.

Presented in a three finishes; Matt Black, Matt Ivory and Ivory enamel, the Huntingdon 40 can be chosen with a tracery door for refined style or clear door for an uninterrupted view of the realistic log bed and rolling flames, allowing you to select the styling that fits your décor.

For added convenience, the Huntingdon 40 can be upgraded from manual operation with a choice of optional handsets for remote control as well as programmable thermostatic and timer functionality.

Colour Choice

Matt Black
Matt Ivory
Ivory

Heat Output

2.78 - 5.54kW 

Efficiency

Conventional flue 75%
Balanced flue 84%

Fuel Bed

Logs

Command Controls

Manual
Standard upgradeable
Programmable Thermostatic upgradeable

Chimney Types

(please see pages 8-9)

*Efficiency figures given are based upon the maximum heat output achieved for these models.
For complete model choices, specifications and additional information please see pages 50-54 and 59*

Electric Huntingdon 30



The fine castings and beautiful tracery door of the Huntingdon 30 Electric are brought alive with Gazco's VeriFlame™ technology which provides you with two heat settings that can both be thermostatically controlled; three flame brightness levels, plus the additional option for a blue flame effect on the high setting. Your choice of fire is then set against the highly realistic fuel bed and individually hand painted logs, perfectly mirroring the look and atmosphere of a real woodburning stove.

Operation is simple too as the remote control* not only allows selection of the flame and glow but also fire/heat combinations.

* The thermostat is controlled manually from the stove.

Also see image on page 51.

Colour Choice

Matt Black
Matt Ivory
Ivory

Heat Output

1.00 - 2.00kW 

Efficiency

99.8%

Fuel Bed

Logs

Command Controls

Remote as standard

Chimney Types



No chimney required



Efficiency figures given are based upon the maximum heat output achieved for these models.



Gas Ashdon



Gas Ashdon conventional flue in Laurel Green enamel with coal-effect fire



Gas Ashdon conventional flue in Midnight Blue enamel with coal-effect fire

Refinement & performance are very much the hallmarks of the Gas Ashdon. Its graceful lines & fine Gothic tracery window combined with the latest gas fire technology provide a superb focal point for your home.

There is a choice of traditional Matt Black, Matt Ivory, lustrous Midnight Blue, Laurel Green or Ivory enamel finishes; coal or log fuel beds; Standard upgradeable & Programmable Thermostatic upgradeable remote controls.

Colour Choice

Matt Black
Matt Ivory
Laurel Green
Midnight Blue
Ivory

Heat Output

2.50 - 5.28kW 

Efficiency

Conventional flue 78%
Balanced flue 82%

Fuel Bed

Logs
Coals

Command Controls

Manual
Standard upgradeable
Programmable Thermostatic upgradeable

Chimney Types

(please see pages 8-9)

Efficiency figures given are based upon the maximum heat output achieved for these models.

For complete model choices, specifications and additional information please see pages 50-54 and 60







Gas Ashdon - Clear Door



Gas Ashdon with clear door in Laurel Green enamel & coal-effect fire

For those who admire the fine lines and heating capacity of the Gas Ashdon, there is the choice of a clear door version. Identical in performance, size and finish options to the Gas Ashdon, the clear door version is for those who crave the fullest possible flame picture without compromise.

Colour Choice

Matt Black
Matt Ivory
Laurel Green
Midnight Blue
Ivory

Heat Output

2.50 - 5.28kW

Efficiency

Conventional flue 78%
Balanced flue 82%

Fuel Bed

Logs
Coals

Command Controls

Manual
Standard upgradeable
Programmable Thermostatic upgradeable

Chimney Types

(please see pages 8-9)

Efficiency figures given are based upon the maximum heat output achieved for these models.

For complete model choices, specifications and additional information please see pages 50-54 and 60

Electric Ashdon



Gazco's popular electric stove features our unique VeriFlame™ technology. It offers a superbly realistic log-effect fire with three different brightness intensities, the additional option for a blue flame effect on the high setting plus two heat settings that can both be thermostatically controlled. Quite simply, it means that you can enjoy all the ambience of a genuine cast iron wood burner with the convenience of a remote control*.

From the hand painted fuel bed and logs to the lustrous enamel and painted finishes, this stove exudes the style and quality to make an impressive focal point in any home.

** The thermostat is controlled manually from the stove.*

Also see image on page 49.

Colour Choice

Matt Black
Matt Ivory
Laurel Green
Midnight Blue
Ivory

Heat Output

1.00 - 2.00kW 

Efficiency

99.8%

Fuel Bed

Logs

Command Controls

Remote as standard

Chimney Types



No chimney required

Efficiency figures given are based upon the maximum heat output achieved for these models.

For complete model choices, specifications and additional information please see pages 50-51, 56 and 60.







Gas Steel Manhattan



The contemporary Steel Manhattan offers you even more opportunities to co-ordinate with today's more modern décors, room sizes and furnishings, especially as there are two sizes and each is available in a choice of two finishes.

Whichever way you look at the Steel Manhattan, as a piece of furniture or as a heating appliance, this precision-engineered gas stove provides an outstanding focal point for any room. The striking steel design is complemented by a matt black cast iron top grille that convects the heat into the room.

Please see further image on page 61.

Finish Choice

Anthracite
Brushed Stainless Steel

Fuel Bed

Logs

Sizes Available

Small
Medium

Heat Output

S: 1.76 - 2.85kW
M: 2.50 - 5.28kW

Efficiency

Conventional flue 78%
Balanced flue 82%

Command Controls

Manual
Standard upgradeable
Programmable Thermostatic upgradeable

Chimney Types

1 **2** **BF** **PF**
(please see pages 8-9)

Efficiency figures given are based upon the maximum heat output achieved for these models.

For complete model choices, specifications and additional information please see pages 44-48 and 54

Electric Steel Manhattan





The small and medium Electric Steel Manhattan stoves provide clean lines and contemporary styling with a highly realistic log-effect fire and up to 2kW of heat output at the press of a button on the remote control.

Both models incorporate Gazco's VeriFlame™ technology offering you three different flame intensities and two heat settings, that can be thermostatically controlled*, and you can even enjoy the flame effect without the heat. There is a choice of two modern finishes to blend with a wide range of interiors.

Colour Choice

Anthracite
Brushed Stainless Steel

Heat Output

S: 1.00 - 2.00kW 
M: 1.00 - 2.00kW 

Efficiency

99.8%

Fuel Bed

Logs

Sizes Available

Small
Medium

Command Controls

Remote as standard

Chimney Types

No chimney required

Efficiency figures given are based upon the maximum heat output achieved for these models.

For complete model choices, specifications and additional information please see pages 50-51, 55 and 61.







Gas Riva Vision



Gas Riva Vision Medium with log effect fuel bed



Gas Riva Vision Small, balanced flue with log effect fuel bed

Offered in four sizes (Riva Vision Large overleaf) which all feature an eye-catching glass-fronted door and integral glass plinth, the high quality Gas Riva Vision is a sparkling addition to the Gazco stoves range. The Small, Midi and Medium models feature our latest highly-realistic log effect fire with glowing ember bed.

The flames on the Riva Vision Medium are enhanced further by the stainless steel lining panels, creating extra illumination in the stove with a mirror-like finish that echoes the Vision's reflective exterior!

To further increase your interior design possibilities, why not also opt for a contemporary stove bench (see page 66) or black gloss flue pipe* - the perfect complement to these stylish contemporary stoves.

Finish

Black Glass

Fuel Bed

Logs

Sizes Available

Small

Midi

Medium

Heat Output

Small: 2.40 - 2.56kW

Midi: 3.26 - 3.44kW

Medium: 2.78 - 5.54kW

Efficiency

Conventional flue 75%

Balanced flue 84%

Command Controls

Manual

Standard upgradeable

Programmable Thermostatic upgradeable

Chimney Types

1 2 BF

(please see pages 8-9)

*Conventional flue only

Efficiency figures given are based upon the maximum heat output achieved for these models.

For complete model choices, specifications and additional information please see pages 50-54 and 63.

For Riva Bench options please see page 66.

Gas Riva Vision Large



The Gas Riva Vision large offers a greater heat output than its Small, Midi & Medium equivalents, providing a comforting warmth for larger rooms. There is a choice of either a realistic log or contemporary white stone fuel effect, with the option to customise your white stone fire with a choice of three glass bead sets. The log-effect models can be styled even further with a choice of either the timeless black reeded or the lighter vermiculite linings. Whichever you choose, these high-efficiency, stunning flame effects are displayed to their full potential in this wide screen format, complemented by the sleek glass styling and ease of use from the Programmable Thermostatic remote control.

For conventional flue versions you can also opt for gloss black flue pipe to continue its reflective qualities and really create that designer look. Consider including a stove bench to further accentuate the contemporary styling (see page 66 for more details).

Finish Choice

Black Glass

Heat Output

4.85 - 5.20kW 

Efficiency

Conventional flue 70%

Balanced flue 81%

Chimney Types

1 **2** **BF**

(please see pages 8-9)

Linings

Vermiculite (Log Effect)

Black Reeded (Log Effect)

Black Enamel (White Stone or Glass Beads)

Fuel Beds (see right)

White Stones

Logs

Red, Clear or Black Glass Beads†

Command Controls

Programmable

Thermostatic Remote



†Glass Beads are available as an upgrade to White Stone models. Please note that Red Glass beads will darken when burning and then return to their original colour when cool.

Efficiency figures given are based upon the maximum heat output achieved for these models.





Electric Riva Vision



The Riva Vision is a contemporary, electric stove that comes in three sizes: Small, Midi & Medium; each sporting a highly reflective black glass door, integral glass plinth, black glass top plate and stainless steel detailing for a clean stylish look.

Incorporating an eye-catching flame effect created using Gazco's unique VeriFlame™ technology, the Riva Vision's alluring visuals glow over a realistic hand painted log-effect fuel bed to give all the ambiance and depth of a real log fire. To increase your interior design possibilities, you can enhance your Riva Vision by choosing from one of ten stylish Riva Stove Benches as shown on page 66.

**The thermostat is controlled manually from the stove.
Electric Riva Vision Small is shown on page 51*



Finish Choice

Black Glass

Fuel Bed

Logs

Heat Output

Small: 1.00 - 2.00kW

Midi: 1.00 - 2.00kW

Medium: 1.00 - 2.00kW



Efficiency

99.8%

Command Controls

Remote as standard

Chimney Types



No Chimney Required

*Efficiency figures given are based upon the maximum heat output achieved for these models.
For complete model choices, specifications and additional information please see pages 50-51, 55 and 63.*

Riva2 F670 Glass



Riva2 F670 Glass, conventional flue with Brick-effect Lining

Combining exceptional aesthetics with the latest gas fire innovations, the Riva2 F670 Glass effortlessly creates a focal point in any room – whilst providing a high level of heating performance and high efficiency.

The F670's realistic log-effect fire is complimented by a choice of linings including classic Brick Effect, contemporary Vermiculite, elegant Black Reeded, and depth-enhancing, reflective Black Glass, allowing you to customise your stove to your personal tastes.

Riva2 F670 is a freestanding stove for hearth mounted installations, but for optimal versatility, is also offered with the striking Apex stand (shown overleaf) or with Gazco's range of contemporary stove benches.

Finish

Black Glass

Lining Choice

Vermiculite
Brick-effect
Black Reeded
Black Glass

Heat Output

3.20 - 5.60kW 

Fuel Bed

Logs

Efficiency

Conventional flue 75%
Balanced flue 82%

Command Controls

Programmable Thermostatic Remote

Chimney Types

1 **2** **BF**

(please see pages 8-9)

Efficiency figures given are based upon the maximum heat output achieved for these models.

For complete model choices, specifications and additional information please see pages 50-54, 62 and 66.





Riva2 F670 Glass, balanced flue with Black Glass Lining on Riva 120 High Bench

*Riva2 F670 Steel, balanced flue with
Black Reeded Lining*



Riva2 F670 Steel



Offered in a stylish Graphite steel front, the F670 Steel is a style alternative to the Glass model shown on the previous page and therefore shares all the same firebox technology.

The F670 is ideal for corner installations due to its subtly tapered shape. This tapering is also echoed in the specifically designed, geometric Apex stand that elevates the fire for a truly unique designer statement.

These cutting edge gas stoves are capable of producing up to 5.60kW of heat, with an outstanding 82% efficiency, all with the ultimate ease of use thanks to its Programmable Thermostatic handset. Featuring both timer and thermostatic temperature controls, the F670 ensures you always have a warm welcome home.

Finish

Graphite

Lining Choice

Vermiculite
Brick-effect
Black Reeded
Black Glass

Heat Output

3.20 - 5.60kW 

Fuel Bed

Logs

Efficiency

Conventional flue 75%
Balanced flue 82%

Command Controls

Programmable Thermostatic Remote

Chimney Types

1 **2** **BF**

(please see pages 8-9)

Efficiency figures given are based upon the maximum heat output achieved for these models.

For complete model choices, specifications and additional information please see pages 50-54, 62 and 66



*Studio 2 Freestanding with White front and matching bench,
log-effect fuel bed and Black Reeded lining*

Studio Freestanding Gas



Studio 1 Freestanding with Black front and matching plinth, log-effect fuel bed and Vermiculite lining

The Studio Freestanding fires represent the ultimate in gas fire design, blending geometric angles with sweeping curves to create a striking, contemporary centrepiece in your home.

These high efficiency fires are available with a choice of a smoothly curving bench or plinth, each echoing the distinctive design of the fire and offered in either White or Black front finishes. There is also a range of lining and fuel effect choices to further add to your styling possibilities. The Programmable Thermostatic remote offers complete control and convenience.

See page 3 for White Stone model.

Finish Choices

Black or White Fronted

Mounting Choices

Plinth or Bench

Heat Output

4.85 - 6.97kW 

Efficiency

Conventional flue 78%
Balanced flue 81%

Chimney Types

1 **2** **BF**

(please see pages 8-9)

Linings

Vermiculite (Log Effect)
Black Reeded (Log Effect)
Black Enamel (White Stone or Glass Beads)

Fuel Beds (see right)

White Stones
Logs
Red, Clear or Black Glass Beads†

Command Controls

Programmable
Thermostatic Remote



Clear Glass Beads

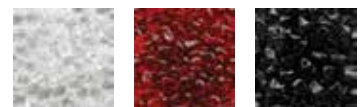

Clear Glass Beads

Red Glass Beads

Black Glass Beads

†Glass Beads are available as an upgrade to White Stone models. Please note that Red Glass beads will darken when burning and then return to their original colour when cool.

Efficiency figures given are based upon the maximum heat output achieved for these models.

For complete model choices, specifications and additional information please see pages 50-54 and 64.

Additional Information









Impressive features

All Gazco gas stoves have an outstanding list of standard features:

- **Ceramic fibre coals, logs or driftwood** - skilfully sculpted for maximum 'real fire' effect and atmosphere
- **Multi-purpose control knobs**- for simple, fingertip control of ignition, pilot light and gas supply
- **Piezo ignition** - automatic sparking without batteries or electricity
- **Adjustable flame setting** - infinitely adjustable between high and low
- **Convection system** - for improved heating efficiency and safety
- **Flame failure device** - automatically shuts off the gas supply if the pilot light goes out
- **Flue Sure System[®]** - Gazco's special safety system shuts off the gas supply in the case of accidental flue blockage (conventional flue models only)
- **Choice of flue exit** - top or rear exit options for greater flexibility of installation (except small balanced flue models which are rear exit only)

Colour/finish choices

According to model, the colour/finishes available are shown below:

	Matt Black - 2		Ivory - 1
	Midnight Blue - 1		Matt Ivory - 2
	Laurel Green - 1		Brushed Stainless Steel - 3
	Anthracite - 2		Black Glass - 4
	Graphite - 2		

1 = Enamel finish
2 = Paint finish
3 = Steel finish
4 = Glass finish

Command remote controls

Gas Stoves

Gazco was the first UK company to introduce remote controls for gas fires. Today, our Command remote control systems allow most stoves to be upgraded, either at the time of purchase or at a later date, with either:



a) Standard upgradeable remote control

Once the pilot light has been ignited manually you can vary the flame height and heat output from the comfort of your armchair.



b) Programmable Thermostatic upgradeable remote control

This deluxe version has two additional features. The first allows you to thermostatically control the room temperature whilst the second allows you to programme your stove to switch itself on and off twice a day. Use both and you can even come home to a glowing fire that has heated the room to the temperature you select.



c) Programmable Thermostatic remote control for Gas Riva Vision Large, Riva2 F670 and Studio Freestanding

This deluxe remote is loaded with exciting features that make it possible to programme your stove to perfectly complement your lifestyle. Not only can you ignite, extinguish and thermostatically control your stove, this remote control system benefits from advanced technology that gives you the option to create an automatic, intelligent heating program that means your home is comfortable and cosy at any time of the day or night.

Electric Stoves

Our range of Electric Stoves are as easy to install as plugging in and switching on! They are available in a range of designs from traditional to modern, ensuring that there is an electric stove available to suit all pockets and locations. The heater and VeriFlame™ controls for each fire are discreetly located under the stove and can be operated using the supplied remote*.

The VeriFlame™ technology consists of two heat settings that can both be thermostatically controlled, three flame intensities, plus the additional option of a blue flame effect on the high setting - so you can mix and match to create the perfect ambience. Select from fire effect only, fire effect + 1kW heat and fire effect + 2kW heat. Every VeriFlame™ setting beautifully highlights the highly realistic hand painted log-effect glass fibre fuel bed.

**The thermostat is controlled manually from the stove.*



The Gazco VeriFlame™ Difference

Unique on the market, Gazco's VeriFlame™ technology produces the ultimate in realistic fire effects. The complementary remote control allows you to independently adjust the brightness and colour of the flames and fuel bed so you can produce the exact ambience you require. Complete flexibility at the touch of a button. There are also discreetly concealed manual controls should the batteries in the remote control run out of power.

Technical Specifications

All specifications given in the main part of this brochure are approximate. Actual specifications for each individual product will vary according to the exact model and are given on pages 52-66. Your Gazco retailer will be pleased to help explain specific model specifications and provide any further information you may require, or you can view/download specification sheets from www.gazco.com.

Installation and Safety

Gazco gas stoves must be fitted by a qualified gas installer (Gas Safe registered in the United Kingdom or Bord Gais registered in the Republic of Ireland) who should also verify the proposed site conditions are fully suitable for the product selected. Complete installation instructions for many models can be obtained prior to purchase by downloading them from www.gazco.com.

Please note that all parts of these stoves become extremely hot during operation and can result in serious injury and burns if touched. It is therefore recommended that a fireguard complying with BS 8423:2002 is used in the presence of young children, the elderly or infirm.

Colours

Owing to variations in studio lighting and printing inks, the colours of stoves illustrated in this brochure may differ slightly from actual models.

Product Improvement & Brochure Photography

Gazco pursue a policy of continuous product improvement, therefore, whilst our products are correct at the time of the photography, we reserve the right to make alterations and amendments. Exact product details should be discussed with your retailer at the time of purchase.

All fire and flame photography has been taken from genuine products; however, the exact appearance of the flame picture for any appliance will vary depending on the nature of the flue type, installation surroundings, local geographical features and the way in which the appliance is operated.

Given that building regulations are subject to constant change, some of the photography in this brochure may not comply with the requirements of the latest Building Regulations and you should always check your proposed installation arrangement with your qualified gas installer before proceeding. Certain settings in this brochure are dependant on the use of heat shields to reduce the required separation from combustible material.

Please note: The operation and appearance of gas appliances depends on variable factors such as the gas pressure supplied.

Warranty information

Your Gazco Expert Retailer will provide you with a Two Year Warranty for your new gas or electric stove. The warranty for gas stoves can be extended to a period of five years by registering your stove with Gazco. Please note, these warranties exclude certain consumable parts. Stoves purchased outside of Gazco's Expert Retailer Network will carry a standard 1 Year non-extendable Warranty. Full warranty terms & conditions are available to view at www.gazco.com



Gas Stockton 5 balanced flue with log-effect fire



Electric Riva Vision Small



GAS STOVES - dimensions and options

Model	Overall dimensions (mm)			Approx weight (kg)	Conventional or Pre-fabricated flue
	Width	Height	Depth		
Gas Marlborough - Matt Black only					
Small	410	533	360	35	✓
Medium	590	583	410	48	✓
Large	730	628	420	56	✓

Gas Stockton - Matt Black only					
Small	422	525	340	57	✓
Stockton 5	481	544	337	55	✓
Medium	579	618	411	77	✓

Gas Huntingdon - Matt Black, Matt Ivory and Ivory Enamel					
Gas Huntingdon 20	416	535	320	45	-
Gas Huntingdon 30	560	592	351	72	✓
Gas Huntingdon 40	641	653	382	CF: 71 BF: 75	-

Gas Ashdon - Matt Black, Laurel Green, Midnight Blue, Ivory and Matt Ivory					
Medium	654	652	515	88	✓
Medium - clear glass	654	652	515	86	✓

Gas Steel Manhattan - Anthracite and Brushed Stainless Steel					
Small	540	633	360	64	-
Medium	709	683	425	80	-

Gas Riva2 F670 - Black Glass and Steel					
Riva2 F670	737	572	385	CF: 52 BF: 54	-

Gas Riva Vision - Black Glass					
Small - Conventional Flue	370	529	289	33	-
Small - Balanced Flue	370	529	289	35	-
Midi - Conventional Flue	415	605	311	39	-
Midi - Balanced Flue	415	605	311	41	-
Medium - Conventional Flue	535	677	353	45	-
Medium - Balanced Flue	535	677	353	55	-
Large - Conventional Flue	876	631	390	74.5	-
Large - Balanced Flue	876	656	375	78.5	-

Gas Studio Freestanding - Black and White					
Studio Freestanding 1 - Bench Mounted	896	1150	396	146	-
Studio Freestanding 1 - Plinth Mounted	649	1105	485	141.5	-
Studio Freestanding 2 - Bench Mounted	896	1350	396	148	-
Studio Freestanding 2 - Plinth Mounted	649	1305	485	143.5	-

Important Notes:

1. Conventional Flue Pipe and options:
for flue pipe codes and options such as flue collars, closure plates and spigot extensions, please see price list.

2. Balanced Flue:
in addition, please order appropriate flue kit and optional flue collar. Please see price list for details.

3. Powered Flue:
please order powered flue kit and, if terminal is to be less than 2m above ground level, a terminal guard is also required.

4. *: indicates product is available with rear flue exit only.
†: indicates product is available with top flue exit only.

5. All other products are top or rear.

Coal fire		Log fire		White Stones	
Pre-cast flue	Powered flue	Conventional or Pre-fabricated	Balanced flue	Conventional or Pre-fabricated	Balanced flue
✓	✓	-	✓*	-	-
-	✓	✓	✓	-	-
-	✓	-	-	-	-
✓	✓	-	✓*	-	-
-	-	-	✓	-	-
-	✓	✓	✓	-	-
-	-	✓	✓*	-	-
-	-	✓	✓	-	-
-	-	✓	✓	-	-
-	✓	✓	✓	-	-
-	✓	✓	✓	-	-
-	-	-	✓*	-	-
-	-	✓	✓	-	-
-	-	✓	✓	-	-
-	-	✓	✓	-	-
-	-	✓	✓	-	-
-	-	✓	✓*	-	-
-	-	✓	✓	-	-
-	-	✓	✓	-	-
-	-	✓	✓	-	-
-	-	✓	✓	-	-
-	-	✓†	-	✓†	-
-	-	-	✓†	-	✓†
-	-	✓†	✓†	✓†	✓†
-	-	✓†	✓†	✓†	✓†
-	-	✓†	✓†	✓†	✓†
-	-	✓†	✓†	✓†	✓†

GAS FLUE SYSTEMS

1. Closure Plate and Spigot Extension^Δ

This is a flue system suitable for homes with existing conventional chimneys in which an airtight, steel closure plate is fitted over a fireplace opening or Class 2 pre-cast starter block and a short piece of flue extends from the back of the stove, through the plate, into the chimney. The products of combustion are carried up the chimney by natural convection.

Models which can be fitted with a closure plate and spigot extension are:

Small Gas Marlborough, Small Gas Stockton, Medium Gas Marlborough and Medium Gas Stockton.

Models which can be fitted to a pre-cast chimney with a closure plate are:

Small Gas Marlborough and Small Gas Stockton

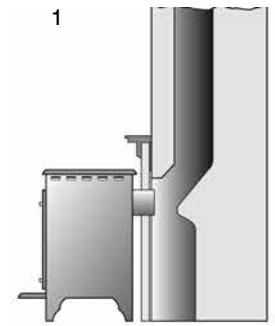

2. Rigid or Flexible Metal Flue^Δ

With this flue system rigid metal tubes, or a combination of rigid and flexible metal tubes, extend vertically directly from the stove to the outside of the property. This may be either straight through the ceiling or roof with the flue pipe exposed, or by using the channel of a chimney or a studwork enclosure. The products of combustion are carried up the flue by natural convection.

Models which can use this system are:

Small, Medium and Large Gas Marlborough, Small and Medium Gas Stockton, Gas Stockton 5, Huntingdon 20, Huntingdon 30, Huntingdon 40, Gas Ashdon and clear glass, Small and Medium Steel Manhattan, Gas Riva Vision Small, Midi, Medium & Large[†], Studio 1 and 2 Freestanding and Riva2 F670. ([†] Top outlet only)

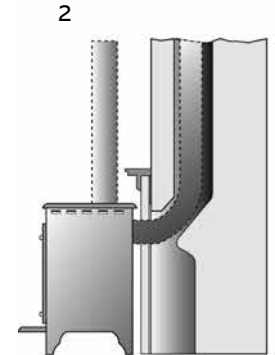

3. Balanced Flue

Where a room has no chimney, then a Balanced Flue version of a Gazco stove is a practical option. The flue consists of one tube inside another. The outer tube brings air into the stove for combustion whilst the inner one emits the products of combustion.

Options: A - Rear outlet (max 600mm wall thickness).

B - Top outlet/up and out (min rise 500mm, max 3m), horizontal (min 250mm, max 5m).

An additional bend can be incorporated in to the horizontal section of the 'up and out', dependent upon a 1m min vertical rise.

C - Top outlet/vertical (min 3m, max 10m).

D - Top outlet/vertical with offset (min to first bend 500mm, max flue length 10m).

Ask your retailer for full technical details or see our Concentric Flue System brochure at www.gazco.com.

Models which can use this system are:

Small* and Medium Gas Marlborough, Small* and Medium Gas Stockton, Gas Stockton 5, Gas Huntingdon 20*, 30 and 40, Gas Ashdon and clear glass, Small*, Medium Steel Manhattan, Gas Riva Vision Small, Midi, Medium & Large[†]. Studio 1 and 2 Freestanding and Riva2 F670. (*Rear outlet only [†] Top outlet only). All Balanced Flue models are log effect only.

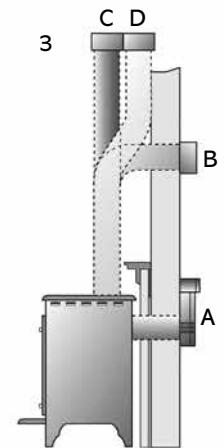

4. Powered Flue

Where a room has no chimney then a Powered Flue is the answer. It is a special extractor unit which attaches to an outside wall and removes the products of combustion, along a rigid metal pipe by fan action. Generally the flue pipe can be of longer lengths than with a Balanced Flue and can also include a number of 90° bends.

Models which can use this system are:

Small, Medium and Large Gas Marlborough, Small and Medium Gas Stockton, Gas Ashdon and clear glass, and Medium Steel Manhattan.

Use Powered Flue with coal effect only.

^Δ Due to the high efficiency and the limited flue flow of the closed convector stoves, a 5" (125mm) flexible flue liner is required when installing the stoves into a brick chimney or a larger than 5" (125mm) diameter lined flue. The only exception to this is stoves that are listed as suitable for installation with a Gazco closure plate and spigot over a standard 22" x16" fire opening.

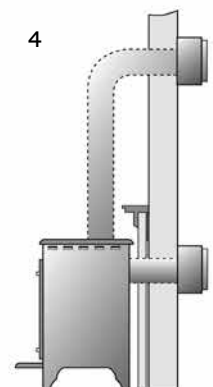

ELECTRIC STOVES - dimensions and options

Model	Overall dimensions (mm)			Approx weight (kg)	Log Fire Electric No flue req.
	W	H	D		
Electric Marlborough - Matt Black only					
Small	410	559	360	35	✓
Medium	590	583	410	48	✓
Electric Stockton - Matt Black only					
Small	422	525	340	57	✓
Stockton 5	481	544	337	55	✓
Medium	579	618	411	82	✓
Electric Huntingdon 30 - Matt Black					
	560	592	351	71.5	✓
Electric Ashdon - Matt Black, Laurel Green, Midnight Blue, Ivory and Matt Ivory					
	654	652	515	78	✓
Electric Steel Manhattan - Anthracite and Brushed Stainless Steel					
Small	540	635	360	33	✓
Medium	711	700	427	44	✓
Electric Riva Vision - Black Glass					
Small	370	555	297	24	✓
Midi	415	604	317	28	✓
Medium	535	676	363	38	✓



Electric Ashdon in Matt Black

Gas and Electric Marlborough

Product Code	Model	Colour	Flue Type	Logs/ Coals	Fuel Type	Heat Input	Heat Output	Efficiency
⊗ 8560	Small	Matt Black	Conventional	Coals	Nat.Gas	4.55kW	3.55kW	78%
⊗ 8536	Small	Matt Black	Balanced	Logs	Nat.Gas	3.65kW	2.85kW	78%
⊗ 8564	Medium	Matt Black	Conventional	Coals	Nat.Gas	6.60kW	5.15kW	78%
⊗ 8610LUC	Medium	Matt Black	Conventional	Logs	Nat.Gas	6.60kW	5.28kW	80%
⊗ 8535LUC	Medium	Matt Black	Balanced	Logs	Nat.Gas	6.40kW	5.25kW	82%
8568	Large	Matt Black	Conventional	Coals	Nat.Gas	8.90kW	6.95kW	78%
⊗ P8560	Small	Matt Black	Conventional	Coals	LPG	4.60kW	3.60kW	78%
⊗ P8536	Small	Matt Black	Balanced	Logs	LPG	3.65kW	2.85kW	78%
⊗ P8564	Medium	Matt Black	Conventional	Coals	LPG	6.30kW	4.90kW	78%
⊗ P8610LUC	Medium	Matt Black	Conventional	Logs	LPG	6.40kW	5.25kW	82%
⊗ P8535LUC	Medium	Matt Black	Balanced	Logs	LPG	6.15kW	5.04kW	82%
P8568	Large	Matt Black	Conventional	Coals	LPG	9.30kW	7.25kW	78%
⊗ E8560	Small	Matt Black	N/A	Logs	Elec	–	2.00kW	99%
⊗ E8610	Medium	Matt Black	N/A	Logs	Elec	–	2.00kW	99%

Marlborough Dimensions (see letters on diagram)

	A		B		C		D		E		F	
	ins	mm	ins	mm	ins	mm	ins	mm	ins	mm	ins	mm
Small	16 ³ / ₈	410	21 [*]	533 [*]	14 ¹ / ₈	360	11	280	13 ⁷ / ₈	352	4 ³ / ₈	111
Medium	23 ³ / ₄	590	23	583	16 ¹ / ₈	410	13	330	15 ³ / ₄	401	4	101
Large	28 ³ / ₄	730	24 ³ / ₄	628	16 ¹ / ₂	420	13 ³ / ₈	340	17 ¹ / ₂	446	4	101

* Small Electric Marlborough is 1" (25mm) higher.

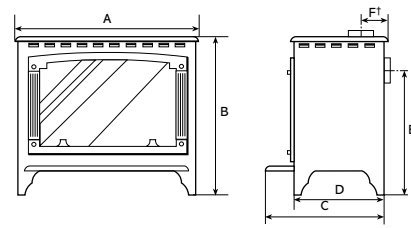

† (Balanced flue version 5¹/₄" 134mm).

* (Small balanced flue version 14¹/₂" 370mm).

* (Medium balanced flue version 17⁷/₈" 453mm).

Recommended clearances between stove and other surfaces: top 9" (225mm), sides 6" (150mm), rear must be a minimum of 2" (50mm).

The Marlborough has a choice of top or rear flue exit and can be supplied with an optional rear closure plate: Small (**8108**), Medium (**8109**) and spigot extension (**8111**). Small balanced flue stoves are rear exit only.

Stove Flue Pipe

Balanced flue versions of the Gas Marlborough must only use the 6" stainless steel flue provided. For additional Matt Black flue collars, please see the Gazco Stoves price list. Gazco recommends the use of 5" matt black enamelled stove pipe with the conventional flue version Marlborough stove. The components usually required are:

Description	Product Code
1' Straight pipe	4500
2' Straight pipe	4501
3' Straight pipe	4502
90° long 'elbow' adaptor (9" projection)	4514
Flue collar	8549

Remote Controls for Gas Marlborough

Description	Product Code
Standard Upgradeable Remote Control	8455
Programmable Thermostatic Upgradeable Remote Control	8456

Gas and Electric Stockton

Product Code	Model	Colour	Flue Type	Logs/ Coals	Fuel Type	Heat Input	Heat Output	Efficiency
⊗ 8573	Small	Matt Black	Conventional	Coals	Nat Gas	4.55kW	3.55kW	78%
⊗ 8540	Small	Matt Black	Balanced	Logs	Nat Gas	3.65kW	2.85kW	78%
⊗ 8574	Medium	Matt Black	Conventional	Coals	Nat Gas	6.60kW	5.15kW	78%
⊗ 8575MCUC	5	Matt Black	Conventional	Coals	Nat Gas	4.60kW	3.36kW	73%
⊗ 8563LUC	5	Matt Black	Balanced	Logs	Nat Gas	4.25kW	3.40kW	80%
⊗ 8617LUC	Medium	Matt Black	Conventional	Logs	Nat Gas	6.60kW	5.28kW	80%
⊗ 8570LUC	Medium	Matt Black	Balanced	Logs	Nat Gas	6.40kW	5.25kW	82%
⊗ P8573	Small	Matt Black	Conventional	Coals	LPG	4.60kW	3.60kW	78%
⊗ P8540	Small	Matt Black	Balanced	Logs	LPG	3.65kW	2.85kW	78%
⊗ P8574	Medium	Matt Black	Conventional	Coals	LPG	6.30kW	4.90kW	78%
⊗ P8617LUC	Medium	Matt Black	Conventional	Logs	LPG	6.40kW	5.25kW	82%
⊗ P8570LUC	Medium	Matt Black	Balanced	Logs	LPG	6.15kW	5.04kW	82%
⊗ P8575MCUC	5	Matt Black	Conventional	Coals	LPG	4.40kW	3.21kW	73%
⊗ P8563LUC	5	Matt Black	Balanced	Logs	LPG	4.10kW	3.28kW	80%
⊗ E8573	Small	Matt Black	N/A	Logs	Elec	–	2.00kW	99%
⊗ E8575	5	Matt Black	N/A	Logs	Elec	–	2.00kW	99%
⊗ E8617	Medium	Matt Black	N/A	Logs	Elec	–	2.00kW	99%

Stockton Dimensions (see letters on diagram)

	A		B		C		D*		E†		F	
	ins	mm	ins	mm	ins	mm	ins	mm	ins	mm	ins	mm
Small	16 ³ / ₈	422	20 ³ / ₈	525	11 ¹ / ₂	290	13 ³ / ₈	346	4 ³ / ₈	110	2	50
Medium	22 ³ / ₄	579	24 ³ / ₁₆	618	13 ³ / ₈	345	16 ³ / ₈	425	4	102	2 ³ / ₈	66
5	19	481	21 ¹ / ₂	544	10 ³ / ₄	273	15	380	3 ³ / ₈	92	2 ¹ / ₂	64

The above information is to assist in your choice of a suitable Gazco stove. This is not intended to be all the information required to install your stove. This can be obtained from your local Gazco retailer or you can download the full installation instructions from the Gazco website at www.gazco.com

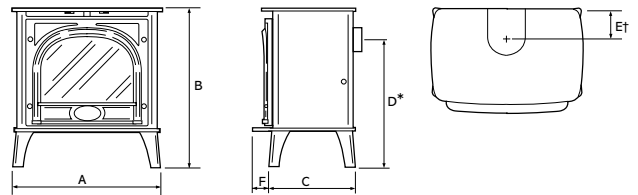

† (Balanced flue version 5¹/₂" 140mm).

* (Small balanced flue version 14¹/₂" 366mm)

* (Medium balanced flue version 19" 482mm)

* (Stockton 5 balanced flue 15¹/₂" 401mm)

Recommended clearances between stove and other surfaces: top 9" (225mm), sides 6" (150mm), rear must be a minimum of 2" (50mm).

The Stockton has a choice of top or rear flue exit. Small and medium models can be supplied with an optional rear closure plates: Small (**8042**), Medium (**8105**) and spigot extension (**8111**). Small balanced flue stoves are rear exit only.

Stove Flue Pipe

Balanced flue versions of the Gas Stockton must only use the 6" stainless steel flue provided. For additional Matt Black, Midnight Blue, Laurel Green and Ivory enamelled flue collars, please see the Gazco Stoves price list. Gazco recommends the use of 5" Matt Black enamelled stove pipe with the conventional flue version. The components required are:

Description	Product Code
1' Straight pipe	4500
2' Straight pipe	4501
3' Straight pipe	4502
90° Long 'elbow' adaptor (9" projection)	4514
Flue collar	8549

Remote Controls for Gas Stockton

Description	Product Code
Standard Upgradeable Remote Control	8455
Programmable Thermostatic Upgradeable Remote Control	8456

Gas Huntingdon 20

Gas Huntingdon 20 Tracery Door

Product Code	Colour	Flue Type	Fuel Effect	Fuel Type	Heat Input	Heat Output	Efficiency
⊗ 515-035	Matt Black	Conventional	Logs	Nat Gas	3.30	2.48	75%
⊗ 515-405	Matt Black	Conventional	Logs	LPG	3.20	2.40	75%
⊗ 515-044	Ivory	Conventional	Logs	Nat Gas	3.30	2.48	75%
⊗ 515-423	Ivory	Conventional	Logs	LPG	3.20	2.40	75%
⊗ 515-053	Matt Ivory	Conventional	Logs	Nat Gas	3.30	2.48	75%
⊗ 515-432	Matt Ivory	Conventional	Logs	LPG	3.20	2.40	75%
⊗ 515-098	Matt Black	Balanced	Logs	Nat Gas	3.20	2.62	82%
⊗ 515-502	Matt Black	Balanced	Logs	LPG	3.10	2.54	82%
⊗ 515-107	Ivory	Balanced	Logs	Nat Gas	3.20	2.62	82%
⊗ 515-511	Ivory	Balanced	Logs	LPG	3.10	2.54	82%
⊗ 515-116	Matt Ivory	Balanced	Logs	Nat Gas	3.20	2.62	82%
⊗ 515-520	Matt Ivory	Balanced	Logs	LPG	3.10	2.54	82%

Gas Huntingdon 20 Clear Door

⊗ 515-071	Matt Black	Conventional	Logs	Nat Gas	3.30	2.48	75%
⊗ 515-441	Matt Black	Conventional	Logs	LPG	3.20	2.40	75%
⊗ 515-080	Ivory	Conventional	Logs	Nat Gas	3.30	2.48	75%
⊗ 515-468	Ivory	Conventional	Logs	LPG	3.20	2.40	75%
⊗ 515-089	Matt Ivory	Conventional	Logs	Nat Gas	3.30	2.48	75%
⊗ 515-477	Matt Ivory	Conventional	Logs	LPG	3.20	2.40	75%
⊗ 515-125	Matt Black	Balanced	Logs	Nat Gas	3.20	2.62	82%
⊗ 515-529	Matt Black	Balanced	Logs	LPG	3.10	2.54	82%
⊗ 515-134	Ivory	Balanced	Logs	Nat Gas	3.20	2.62	82%
⊗ 515-545	Ivory	Balanced	Logs	LPG	3.10	2.54	82%
⊗ 515-143	Matt Ivory	Balanced	Logs	Nat Gas	3.20	2.62	82%
⊗ 515-556	Matt Ivory	Balanced	Logs	LPG	3.10	2.54	82%

Stove Flue Pipe

Balanced flue versions of the Gas Huntingdon 20 must only use the 6" stainless steel flue provided. For additional Matt Black, Matt Ivory and Ivory enamelled flue collars, please see the Gazco Stoves price list. Gazco recommends the use of 5" Matt Black enamelled stove pipe with the conventional flue version. The components required are:

Description	Product Code
1' Straight pipe, Matt Black	4500
2' Straight pipe, Matt Black	4501
3' Straight pipe, Matt Black	4502
90° long 'elbow' adaptor (9" projection), Matt Black	4514
1' Straight pipe, Ivory	4500IV
2' Straight pipe, Ivory	4501IV
3' Straight pipe, Ivory	4502IV
1' Straight pipe, Matt Ivory	4500PI
2' Straight pipe, Matt Ivory	4501PI
3' Straight pipe, Matt Ivory	4502PI
Matt Black Flue collar, Conventional Flue, Huntingdon	999-010
Matt Ivory Flue collar, Conventional Flue, Huntingdon	999-266
Ivory Enamel Flue collar, Conventional Flue, Huntingdon	999-456

Remote Controls for Gas Huntingdon 20

Description	Product Code
Standard Upgradeable Remote Control	8455
Programmable Thermostatic Upgradeable Remote Control	8456

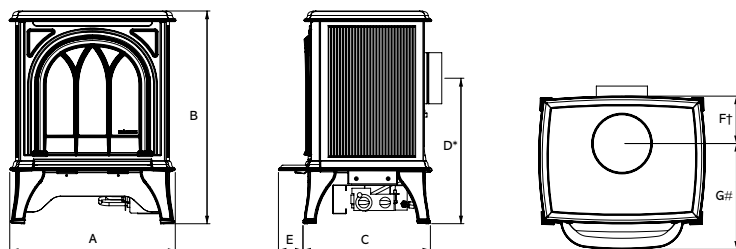

Huntingdon 20 Dimensions (see letters on diagram)

	A		B		C		D*		E		F†		G#	
	ins	mm	ins	mm	ins	mm	ins	mm	ins	mm	ins	mm	ins	mm
20 (CF)	16 3/8	416	21	535	12 1/2	320	14 1/2	366	2 1/2	62	4 3/4	119	10 1/2	266
20 (BF)*	16 3/8	416	21	535	12 1/2	320	15 1/4	386	2 1/2	62	6 1/4	160	8 1/2	225

*Huntingdon 20 Balanced Flue is Rear Exit only.

Recommended clearances between stove and other surfaces:

top 9" (225mm), sides 6" (150mm), rear must be a minimum of 2" (50mm).

The Huntingdon 20 conventional flue has a choice of top or rear flue exit.

Gas and Electric Huntingdon 30

Gas and Electric Huntingdon 30 Tracery Door

Product Code	Colour	Flue Type	Fuel Effect	Fuel Type	Heat Input	Heat Output	Efficiency
⊗ 515-004	Matt Black	Conventional	Logs	Nat Gas	4.55kW	3.40kW	75%
⊗ 515-413	Matt Black	Conventional	Logs	LPG	4.55kW	3.40kW	75%
⊗ 515-154	Ivory	Conventional	Logs	Nat Gas	4.55kW	3.40kW	75%
⊗ 515-484	Ivory	Conventional	Logs	LPG	4.55kW	3.40kW	75%
⊗ 515-212	Matt Ivory	Conventional	Logs	Nat Gas	4.55kW	3.40kW	75%
⊗ 515-536	Matt Ivory	Conventional	Logs	LPG	4.55kW	3.40kW	75%
⊗ 8503CFMCUC	Matt Black	Conventional	Coals	Nat Gas	4.60kW	3.50kW	76%
⊗ P8503CFMCUC	Matt Black	Conventional	Coals	LPG	4.40kW	3.35kW	76%
⊗ 8503CFMCUCIV	Ivory	Conventional	Coals	Nat Gas	4.60kW	3.50kW	76%
⊗ P8503CFMCUCIV	Ivory	Conventional	Coals	LPG	4.40kW	3.35kW	76%
⊗ 515-013	Matt Ivory	Conventional	Coals	Nat Gas	4.60kW	3.50kW	76%
⊗ 515-494	Matt Ivory	Conventional	Coals	LPG	4.40kW	3.35kW	76%
⊗ 515-257	Matt Black	Balanced	Logs	Nat Gas	4.30kW	3.50kW	81%
⊗ 515-561	Matt Black	Balanced	Logs	LPG	4.30kW	3.50kW	81%
⊗ 515-395	Ivory	Balanced	Logs	Nat Gas	4.30kW	3.50kW	81%
⊗ 515-664	Ivory	Balanced	Logs	LPG	4.30kW	3.50kW	81%
⊗ 515-333	Matt Ivory	Balanced	Logs	Nat Gas	4.30kW	3.50kW	81%
⊗ 515-712	Matt Ivory	Balanced	Logs	LPG	4.30kW	3.50kW	81%
⊗ E8503	Matt Black	N/A	Logs	Elec	-	2.00kW	99%
⊗ E8503IV	Ivory	N/A	Logs	Elec	-	2.00kW	99%
⊗ 615-567	Matt Ivory	N/A	Logs	Elec	-	2.00kW	99%

Gas Huntingdon 30 Clear Door

⊗ 515-009	Matt Black	Conventional	Logs	Nat Gas	4.55kW	3.40kW	75%
⊗ 515-453	Matt Black	Conventional	Logs	LPG	4.55kW	3.40kW	75%
⊗ 515-061	Ivory	Conventional	Logs	Nat Gas	4.55kW	3.40kW	75%
⊗ 515-505	Ivory	Conventional	Logs	LPG	4.55kW	3.40kW	75%
⊗ 515-100	Matt Ivory	Conventional	Logs	Nat Gas	4.55kW	3.40kW	75%
⊗ 515-570	Matt Ivory	Conventional	Logs	LPG	4.55kW	3.40kW	75%
⊗ 515-282	Matt Black	Conventional	Coals	Nat Gas	4.60kW	3.50kW	76%
⊗ 515-778	Matt Black	Conventional	Coals	LPG	4.40kW	3.35kW	76%
⊗ 515-348	Ivory	Conventional	Coals	Nat Gas	4.60kW	3.50kW	76%
⊗ 515-796	Ivory	Conventional	Coals	LPG	4.40kW	3.35kW	76%
⊗ 515-299	Matt Ivory	Conventional	Coals	Nat Gas	4.60kW	3.50kW	76%
⊗ 515-698	Matt Ivory	Conventional	Coals	LPG	4.40kW	3.35kW	76%
⊗ 515-139	Matt Black	Balanced	Logs	Nat Gas	4.30kW	3.50kW	81%
⊗ 515-726	Matt Black	Balanced	Logs	LPG	4.30kW	3.50kW	81%
⊗ 515-165	Ivory	Balanced	Logs	Nat Gas	4.30kW	3.50kW	81%
⊗ 515-739	Ivory	Balanced	Logs	LPG	4.30kW	3.50kW	81%
⊗ 515-191	Matt Ivory	Balanced	Logs	Nat Gas	4.30kW	3.50kW	81%
⊗ 515-765	Matt Ivory	Balanced	Logs	LPG	4.30kW	3.50kW	81%

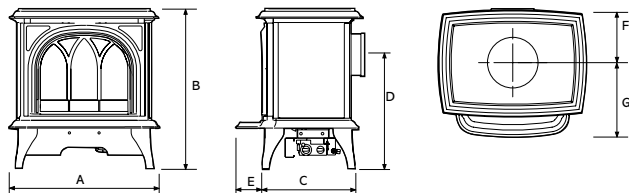

Huntingdon 30 Dimensions (see letters on diagram)

	A		B		C		D*		E		F†		G	
	ins	mm	ins	mm	ins	mm	ins	mm	ins	mm	ins	mm	ins	mm
30 (CF)	22	560	23 ¹ / ₄	592	13 ⁷ / ₈	351	15 ³ / ₄	403	3 ⁵ / ₈	96	6 ⁷ / ₈	174	18 ⁵ / ₈	475
30 (BF)	22	560	23 ¹ / ₄	592	13 ⁷ / ₈	351	16 ⁵ / ₈	422	3 ⁵ / ₈	96	7 ⁵ / ₈	195	18 ⁵ / ₈	475

Stove Flue Pipe

Balanced flue versions of the Gas Huntingdon 30 must only use the 6" stainless steel flue provided. For additional Matt Black, Matt Ivory and Ivory enamelled flue collars, please see the Gazco Stoves price list. Gazco recommends the use of 5" Matt Black enamelled stove pipe with the conventional flue version. The components required are:

Description	Product Code
1' Straight pipe, Matt Black	4500
2' Straight pipe, Matt Black	4501
3' Straight pipe, Matt Black	4502
90° long 'elbow' adaptor (9" projection), Matt Black	4514
1' Straight pipe, Ivory	4500IV
2' Straight pipe, Ivory	4501IV
3' Straight pipe, Ivory	4502IV
1' Straight pipe, Matt Ivory	4500PI
2' Straight pipe, Matt Ivory	4501PI
3' Straight pipe, Matt Ivory	4502PI
Matt Black Flue collar, Conventional Flue, Huntingdon	999-010
Matt Black Flue collar, Balanced Flue, Huntingdon	999-347
Matt Ivory Flue collar, Conventional Flue, Huntingdon	999-266
Matt Ivory Flue collar, Balanced Flue, Huntingdon	999-507
Ivory Enamel Flue collar, Conventional Flue, Huntingdon	999-456
Ivory Enamel Flue collar, Balanced Flue, Huntingdon	999-683

Remote Controls for Gas Huntingdon 30

Description	Product Code
Standard Upgradeable Remote Control	8455
Programmable Thermostatic Upgradeable Remote Control	8456

Gas Huntingdon 30 with clear door and log-effect in Matt Black



Recommended clearances between stove and other surfaces: top 9" (225mm), sides 6" (150mm), rear must be a minimum of 2" (50mm). The Huntingdon 30 has a choice of top or rear flue exit.

Gas and Electric Huntingdon 40

Gas Huntingdon 40 Tracery Door

Product Code	Colour	Flue Type	Fuel Effect	Fuel Type	Heat Input	Heat Output	Efficiency
⊗ 515-161	Matt Black	Conventional	Logs	Nat Gas	6.60	4.95	75%
⊗ 515-565	Matt Black	Conventional	Logs	LPG	6.70	5.03	75%
⊗ 515-170	Ivory	Conventional	Logs	Nat Gas	6.60	4.95	75%
⊗ 515-574	Ivory	Conventional	Logs	LPG	6.70	5.03	75%
⊗ 515-179	Matt Ivory	Conventional	Logs	Nat Gas	6.60	4.95	75%
⊗ 515-583	Matt Ivory	Conventional	Logs	LPG	6.70	5.03	75%
⊗ 515-224	Matt Black	Balanced	Logs	Nat Gas	6.60	5.54	84%
⊗ 515-628	Matt Black	Balanced	Logs	LPG	6.60	5.54	84%
⊗ 515-233	Ivory	Balanced	Logs	Nat Gas	6.60	5.54	84%
⊗ 515-646	Ivory	Balanced	Logs	LPG	6.60	5.54	84%
⊗ 515-242	Matt Ivory	Balanced	Logs	Nat Gas	6.60	5.54	84%
⊗ 515-655	Matt Ivory	Balanced	Logs	LPG	6.60	5.54	84%

Gas Huntingdon 40 Clear Door

⊗ 515-188	Matt Black	Conventional	Logs	Nat Gas	6.60	4.95	75%
⊗ 515-592	Matt Black	Conventional	Logs	LPG	6.70	5.03	75%
⊗ 515-197	Ivory	Conventional	Logs	Nat Gas	6.60	4.95	75%
⊗ 515-601	Ivory	Conventional	Logs	LPG	6.70	5.03	75%
⊗ 515-206	Matt Ivory	Conventional	Logs	Nat Gas	6.60	4.95	75%
⊗ 515-619	Matt Ivory	Conventional	Logs	LPG	6.70	5.03	75%
⊗ 515-251	Matt Black	Balanced	Logs	Nat Gas	6.60	5.54	84%
⊗ 515-673	Matt Black	Balanced	Logs	LPG	6.60	5.54	84%
⊗ 515-269	Ivory	Balanced	Logs	Nat Gas	6.60	5.54	84%
⊗ 515-682	Ivory	Balanced	Logs	LPG	6.60	5.54	84%
⊗ 515-278	Matt Ivory	Balanced	Logs	Nat Gas	6.60	5.54	84%
⊗ 515-691	Matt Ivory	Balanced	Logs	LPG	6.60	5.54	84%

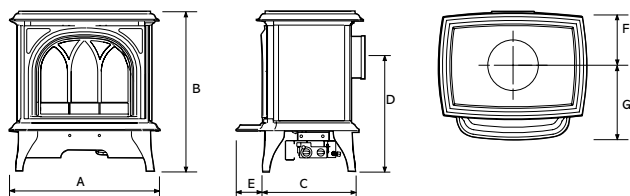

Huntingdon 40 Dimensions (see letters on diagram)

	A		B		C		D		E		F		G	
	ins	mm	ins	mm	ins	mm	ins	mm	ins	mm	ins	mm	ins	mm
40 (CF)	25 1/4	641	25 3/4	653	15	382	14 1/2	366	4	99	6 1/8	154	13 3/4	350
40 (BF)	25 1/4	641	25 3/4	653	15	382	15 1/4	386	4	99	7 1/4	183	12 3/4	321

Stove Flue Pipe

Balanced flue versions of the Gas Huntingdon 40 must only use the 6" stainless steel flue provided. For additional Matt Black, Matt Ivory and Ivory enamelled flue collars, please see the Gazco Stoves price list. Gazco recommends the use of 5" Matt Black enamelled stove pipe with the conventional flue version. The components required are:

Description	Product Code
1' Straight pipe, Matt Black	4500
2' Straight pipe, Matt Black	4501
3' Straight pipe, Matt Black	4502
90° long 'elbow' adaptor (9" projection), Matt Black	4514
1' Straight pipe, Ivory	4500IV
2' Straight pipe, Ivory	4501IV
3' Straight pipe, Ivory	4502IV
1' Straight pipe, Matt Ivory	4500PI
2' Straight pipe, Matt Ivory	4501PI
3' Straight pipe, Matt Ivory	4502PI
Matt Black Flue collar, Conventional Flue, Huntingdon	999-010
Matt Black Flue collar, Balanced Flue, Huntingdon	999-347
Matt Ivory Flue collar, Conventional Flue, Huntingdon	999-266
Matt Ivory Flue collar, Balanced Flue, Huntingdon	999-507
Ivory Enamel Flue collar, Conventional Flue, Huntingdon	999-456
Ivory Enamel Flue collar, Balanced Flue, Huntingdon	999-683

Remote Controls for Gas Huntingdon 30

Description	Product Code
Standard Upgradeable Remote Control	8455
Programmable Thermostatic Upgradeable Remote Control	8456

Recommended clearances between stove and other surfaces:
top 9" (225mm), sides 6" (150mm), rear must be a minimum of 2" (50mm).
The Huntingdon 40 has a choice of top or rear flue exit.

Gas and Electric Ashdon

Product Code	Colour	Flue Type	Logs/ Coals	Fuel Type	Heat Input	Heat Output	Efficiency
⊗ 8513	Matt Black	Conventional	Coals	Nat.Gas	6.60kW	5.15kW	78%
⊗ 8513B	Midnight	Conventional	Coals	Nat.Gas	6.60kW	5.15kW	78%
⊗ 8513G	Laurel	Conventional	Coals	Nat.Gas	6.60kW	5.15kW	78%
⊗ 8513IV	Ivory	Conventional	Coals	Nat.Gas	6.60kW	5.15kW	78%
⊗ 570-006	Matt Ivory	Conventional	Coals	Nat.Gas	6.60kW	5.15kW	78%
⊗ 8613LUC	Matt Black	Conventional	Logs	Nat.Gas	6.60kW	5.28kW	80%
⊗ 8613BLUC	Midnight	Conventional	Logs	Nat.Gas	6.60kW	5.28kW	80%
⊗ 8613GLUC	Laurel	Conventional	Logs	Nat.Gas	6.60kW	5.28kW	80%
⊗ 8613IVLUC	Ivory	Conventional	Logs	Nat.Gas	6.60kW	5.28kW	80%
⊗ 570-022	Matt Ivory	Conventional	Logs	Nat.Gas	6.60kW	5.28kW	80%
⊗ 8546LUC	Matt Black	Balanced	Logs	Nat.Gas	6.40kW	5.25kW	82%
⊗ 8546BLUC	Midnight	Balanced	Logs	Nat.Gas	6.40kW	5.25kW	82%
⊗ 8546GLUC	Laurel	Balanced	Logs	Nat.Gas	6.40kW	5.25kW	82%
⊗ 8546IVLUC	Ivory	Balanced	Logs	Nat.Gas	6.40kW	5.25kW	82%
⊗ 570-040	Matt Ivory	Balanced	Logs	Nat.Gas	6.40kW	5.25kW	82%
⊗ P8513	Matt Black	Conventional	Coals	LPG	6.30kW	4.91kW	78%
⊗ P8513B	Midnight	Conventional	Coals	LPG	6.30kW	4.91kW	78%
⊗ P8513G	Laurel	Conventional	Coals	LPG	6.30kW	4.91kW	78%
⊗ P8513IV	Ivory	Conventional	Coals	LPG	6.30kW	4.91kW	78%
⊗ 570-697	Matt Ivory	Conventional	Coals	LPG	6.30kW	4.91kW	78%
⊗ P8613LUC	Matt Black	Conventional	Logs	LPG	6.40kW	5.25kW	82%
⊗ P8613BLUC	Midnight	Conventional	Logs	LPG	6.40kW	5.25kW	82%
⊗ P8613GLUC	Laurel	Conventional	Logs	LPG	6.40kW	5.25kW	82%
⊗ P8613IVLUC	Ivory	Conventional	Logs	LPG	6.40kW	5.25kW	82%
⊗ 570-664	Matt Ivory	Conventional	Logs	LPG	6.40kW	5.25kW	82%
⊗ P8546LUC	Matt Black	Balanced	Logs	LPG	6.15kW	5.04kW	82%
⊗ P8546BLUC	Midnight	Balanced	Logs	LPG	6.15kW	5.04kW	82%
⊗ P8546GLUC	Laurel	Balanced	Logs	LPG	6.15kW	5.04kW	82%
⊗ P8546IVLUC	Ivory	Balanced	Logs	LPG	6.15kW	5.04kW	82%
⊗ 570-632	Matt Ivory	Balanced	Logs	LPG	6.15kW	5.04kW	82%
⊗ E8613	Matt Black	N/A	Logs	Elec	-	2.00kW	99%
⊗ E8613MB	Midnight	N/A	Logs	Elec	-	2.00kW	99%
⊗ E8613LG	Laurel	N/A	Logs	Elec	-	2.00kW	99%
⊗ E8613IV	Ivory	N/A	Logs	Elec	-	2.00kW	99%
⊗ 670-389	Matt Ivory	N/A	Logs	Elec	-	2.00kW	99%

Gas Ashdon Clear Glass

⊗ 8522	Matt Black	Conventional	Coals	Nat.Gas	6.60kW	5.15kW	78%
⊗ 8522B	Midnight	Conventional	Coals	Nat.Gas	6.60kW	5.15kW	78%
⊗ 8522G	Laurel	Conventional	Coals	Nat.Gas	6.60kW	5.15kW	78%
⊗ 8522V	Ivory	Conventional	Coals	Nat.Gas	6.60kW	5.15kW	78%
⊗ 570-070	Matt Ivory	Conventional	Coals	Nat.Gas	6.60kW	5.15kW	78%
⊗ 8614LUC	Matt Black	Conventional	Logs	Nat.Gas	6.60kW	5.28kW	80%
⊗ 8614BLUC	Midnight	Conventional	Logs	Nat.Gas	6.60kW	5.28kW	80%
⊗ 8614GLUC	Laurel	Conventional	Logs	Nat.Gas	6.60kW	5.28kW	80%
⊗ 8614VLUC	Ivory	Conventional	Logs	Nat.Gas	6.60kW	5.28kW	80%
⊗ 570-099	Matt Ivory	Conventional	Logs	Nat.Gas	6.60kW	5.28kW	80%
⊗ 8544LUC	Matt Black	Balanced	Logs	Nat.Gas	6.40kW	5.25kW	82%
⊗ 8544BLUC	Midnight	Balanced	Logs	Nat.Gas	6.40kW	5.25kW	82%
⊗ 8544GLUC	Laurel	Balanced	Logs	Nat.Gas	6.40kW	5.25kW	82%
⊗ 8544VLUC	Ivory	Balanced	Logs	Nat.Gas	6.40kW	5.25kW	82%
⊗ 570-123	Matt Ivory	Balanced	Logs	Nat.Gas	6.40kW	5.25kW	82%
⊗ P8522	Matt Black	Conventional	Coals	LPG	6.30kW	4.91kW	78%
⊗ P8522B	Midnight	Conventional	Coals	LPG	6.30kW	4.91kW	78%
⊗ P8522G	Laurel	Conventional	Coals	LPG	6.30kW	4.91kW	78%
⊗ P8522V	Ivory	Conventional	Coals	LPG	6.30kW	4.91kW	78%
⊗ 570-601	Matt Ivory	Conventional	Coals	LPG	6.30kW	4.91kW	78%

Longer legs - Matt Black only

A set of longer legs, raising the height of the Ashdon by 2 1/8" (55mm) is available as an optional extra. Product code **8113**.

*Not suitable for use with optional rear closure plate.

Gas Ashdon Clear Glass (continued)

Product Code	Colour	Flue Type	Logs/ Coals	Fuel Type	Heat Input	Heat Output	Efficiency
⊗ P8614LUC	Matt Black	Conventional	Logs	LPG	6.40kW	5.25kW	82%
⊗ P8614BLUC	Midnight	Conventional	Logs	LPG	6.40kW	5.25kW	82%
⊗ P8614GLUC	Laurel	Conventional	Logs	LPG	6.40kW	5.25kW	82%
⊗ P8614IVLUC	Ivory	Conventional	Logs	LPG	6.40kW	5.25kW	82%
⊗ 570-567	Matt Ivory	Conventional	Logs	LPG	6.40kW	5.25kW	82%
⊗ P8544LUC	Matt Black	Balanced	Logs	LPG	6.15kW	5.04kW	82%
⊗ P8544BLUC	Midnight	Balanced	Logs	LPG	6.15kW	5.04kW	82%
⊗ P8544GLUC	Laurel	Balanced	Logs	LPG	6.15kW	5.04kW	82%
⊗ P8544IVLUC	Ivory	Balanced	Logs	LPG	6.15kW	5.04kW	82%
⊗ 570-546	Matt Ivory	Balanced	Logs	LPG	6.15kW	5.04kW	82%

* (Balanced flue version 20 1/2" 520mm).

† (Balanced flue version 6 1/4" 158mm).

Recommended clearances between stove and other surfaces: top 9" (225mm), sides 6" (150mm), rear must be a minimum of 2" (50mm).

The Ashdon has a choice of top or rear flue exit.

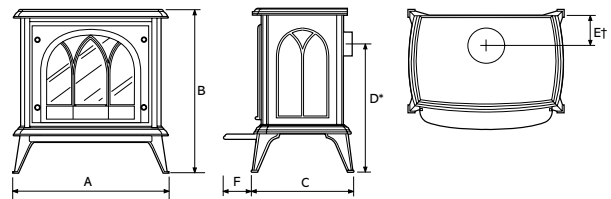

Ashdon Dimensions (see letters on diagram)

	A		B		C		D		E		F	
	ins	mm	ins	mm	ins	mm	ins	mm	ins	mm	ins	mm
Medium	25 3/4	654	25 3/4	652	16 3/4	427	18 1/4	463	5	126	3	75

Stove Flue Pipe (Matt Black, Laurel Green, Midnight Blue Ivory or Matt Ivory)

Balanced flue versions of the Gas Ashdon must only use the 6" stainless steel flue provided. For additional Matt Black, Matt Ivory, Midnight Blue, Laurel Green and Ivory enamelled stove flue collars, please see the Gazco Stoves price list. Gazco recommends the use of 5" enamelled stove pipe with the conventional flue version Ashdon stove. The components usually required are:

Description	Product Code
1' Straight pipe, Matt Black	4500
2' Straight pipe, Matt Black	4501
3' Straight pipe, Matt Black	4502
90° long 'elbow' adaptor (9" projection), Matt Black	4514
1' Straight pipe, Midnight Blue	4500MBL
2' Straight pipe, Midnight Blue	4501MBL
3' Straight pipe, Midnight Blue	4502MBL
1' Straight pipe, Laurel Green	4500LG
2' Straight pipe, Laurel Green	4501LG
3' Straight pipe, Laurel Green	4502LG
1' Straight pipe, Ivory	4500IV
2' Straight pipe, Ivory	4501IV
3' Straight pipe, Ivory	4502IV
1' Straight pipe, Matt Ivory	4500PI
2' Straight pipe, Matt Ivory	4501PI
3' Straight pipe, Matt Ivory	4502PI
Flue collar, Matt Black	8549
Flue collar, Midnight Blue	8549MB
Flue collar, Laurel Green	8549LG
Flue collar, Ivory	8549IV
Flue collar, Matt Ivory	999-407

Remote Controls for Gas Ashdon

Standard Upgradeable Remote Control	8455
Programmable Thermostatic Upgradeable Remote Control	8456

The above information is to assist in your choice of a suitable Gazco stove. This is not intended to be all the information required to install your stove. This can be obtained from your local Gazco retailer or you can download the full installation instructions from the Gazco website at www.gazco.com

Gas and Electric Steel Manhattan

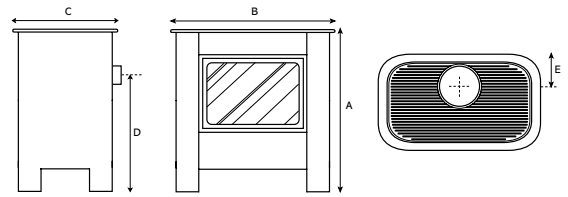

Steel Manhattan Dimensions (see letters on diagram)

Product Code	Model	Steel Finish	Flue Type	Logs/ Coals	Fuel Type	Heat Input	Heat Output	Efficiency
⊗ 8622AN	Small	Anthracite	Bal. Flue	Logs	Nat.Gas	3.65kW	2.85kW	78%
⊗ 8622BS	Small	Brushed Stainless	Bal. Flue	Logs	Nat.Gas	3.65kW	2.85kW	78%
⊗ 8619AN	Medium	Anthracite	Con. Flue	Coals	Nat.Gas	6.60kW	5.15kW	78%
⊗ 8619BS	Medium	Brushed Stainless	Con. Flue	Coals	Nat.Gas	6.60kW	5.15kW	78%
⊗ 8618ANLUC	Medium	Anthracite	Con. Flue	Logs	Nat.Gas	6.60kW	5.28kW	80%
⊗ 8618BSLUC	Medium	Brushed Stainless	Con. Flue	Logs	Nat.Gas	6.60kW	5.28kW	80%
⊗ 8620ANLUC	Medium	Anthracite	Bal. Flue	Logs	Nat.Gas	6.40kW	5.25kW	82%
⊗ 8620BSLUC	Medium	Brushed Stainless	Bal. Flue	Logs	Nat.Gas	6.40kW	5.25kW	82%
⊗ P8622AN	Small	Anthracite	Bal. Flue	Logs	LPG	3.65kW	2.85kW	78%
⊗ P8622BS	Small	Brushed Stainless	Bal. Flue	Logs	LPG	3.65kW	2.85kW	78%
⊗ P8619AN	Medium	Anthracite	Con. Flue	Coals	LPG	6.30kW	4.91kW	78%
⊗ P8619BS	Medium	Brushed Stainless	Con. Flue	Coals	LPG	6.30kW	4.91kW	78%
⊗ P8618ANLUC	Medium	Anthracite	Con. Flue	Logs	LPG	6.40kW	5.25kW	82%
⊗ P8618BSLUC	Medium	Brushed Stainless	Con. Flue	Logs	LPG	6.40kW	5.25kW	82%
⊗ P8620ANLUC	Medium	Anthracite	Bal. Flue	Logs	LPG	6.15kW	5.04kW	82%
⊗ P8620BSLUC	Medium	Brushed Stainless	Bal. Flue	Logs	LPG	6.15kW	5.04kW	82%
⊗ E8622AN	Small	Anthracite	N/A	Logs	Electric	-	2.00kW	99%
⊗ E8622BS	Small	Brushed Stainless	N/A	Logs	Electric	-	2.00kW	99%
⊗ E8619AN	Medium	Anthracite	N/A	Logs	Electric	-	2.00kW	99%
⊗ E8619BS	Medium	Brushed Stainless	N/A	Logs	Electric	-	2.00kW	99%

Product Code	A		B		C		D		E	
	ins	mm	ins	mm	ins	mm	ins	mm	ins	mm
Small Steel	24 1/4	633	21 1/4	540	14 1/4	360	16 1/4	425	-	-
Medium Steel (BF)	26 1/4	683	27 1/4	709	16 1/4	425	20	509	7	177
Medium Steel (CF)	26 1/4	683	27 1/4	709	16 1/4	425	17 1/4	455	5 1/4	144
Small Electric	24 1/4	633	21 1/4	540	14 1/4	360	-	-	-	-
Medium Electric	26 1/4	683	27 1/4	709	16 1/4	425	-	-	-	-

Remote Controls for Gas Steel Manhattan

Standard Upgradeable Remote Control	8455
Programmable Thermostatic Upgradeable Remote Control	8456

Stove Flue Pipes

Balanced flue versions of the Gas Manhattan must only use the 6" stainless steel flue pipe provided. For additional Matt Black enamelled flue collars, please see the Gazco Stoves price list. Gazco recommends the use of 5" matt black enamelled stove pipe with the conventional flue version Manhattan stove. The components usually required are:

Description	Product Code
1' Straight pipe	4500
2' Straight pipe	4501
3' Straight pipe	4502
90° Long 'elbow' adaptor (9" projection)	4514
Flue collar	8549

Recommended clearances between stove and other surfaces: top 9" (225mm), sides 6" (150mm) rear must be a minimum of 2" (50mm).

The Manhattan has a choice of top or rear flue exit. Small steel balanced flue stoves are rear exit only.



Small Electric Steel Manhattan
in Anthracite

Gas Riva2 F670 Glass & Steel

Product Code	Front	CF/BF	Fuel Effect	Lining	Fuel Type	Heat Input (kW)	Heat Output (kW)	Efficiency
⊗ 526-081	Glass	CF	Logs	Vermiculite	Nat. Gas	6.80	5.10	75%
⊗ 526-512	Glass	CF	Logs	Vermiculite	LPG	6.70	5.00	75%
⊗ 526-104	Glass	CF	Logs	Black Reeded	Nat Gas	6.80	5.10	75%
⊗ 526-526	Glass	CF	Logs	Black Reeded	LPG	6.70	5.00	75%
⊗ 526-143	Glass	CF	Logs	Brick Effect	Nat. Gas	6.80	5.10	75%
⊗ 526-537	Glass	CF	Logs	Brick Effect	LPG	6.70	5.00	75%
⊗ 526-169	Glass	CF	Logs	Black Glass	Nat. Gas	6.80	5.10	75%
⊗ 526-564	Glass	CF	Logs	Black Glass	LPG	6.70	5.00	75%

Gas Riva2 F670 Glass Fronted - Balanced Flue

⊗ 526-388	Glass	BF	Logs	Vermiculite	Nat. Gas	6.70	5.50	82%
⊗ 526-720	Glass	BF	Logs	Vermiculite	LPG	6.80	5.60	82%
⊗ 526-351	Glass	BF	Logs	Black Reeded	Nat Gas	6.70	5.50	82%
⊗ 526-733	Glass	BF	Logs	Black Reeded	LPG	6.80	5.60	82%
⊗ 526-364	Glass	BF	Logs	Brick Effect	Nat. Gas	6.70	5.50	82%
⊗ 526-759	Glass	BF	Logs	Brick Effect	LPG	6.80	5.60	82%
⊗ 526-390	Glass	BF	Logs	Black Glass	Nat. Gas	6.70	5.50	82%
⊗ 526-785	Glass	BF	Logs	Black Glass	LPG	6.80	5.60	82%

Gas Riva2 F670 Steel Fronted - Conventional Flue

⊗ 526-003	Steel	CF	Logs	Vermiculite	Nat. Gas	6.80	5.10	75%
⊗ 526-408	Steel	CF	Logs	Vermiculite	LPG	6.70	5.00	75%
⊗ 526-016	Steel	CF	Logs	Black Reeded	Nat Gas	6.80	5.10	75%
⊗ 526-421	Steel	CF	Logs	Black Reeded	LPG	6.70	5.00	75%
⊗ 526-042	Steel	CF	Logs	Brick Effect	Nat. Gas	6.80	5.10	75%
⊗ 526-434	Steel	CF	Logs	Brick Effect	LPG	6.70	5.00	75%
⊗ 526-356	Steel	CF	Logs	Black Glass	Nat. Gas	6.80	5.10	75%
⊗ 526-499	Steel	CF	Logs	Black Glass	LPG	6.70	5.00	75%

Gas Riva2 F670 Steel Fronted - Balanced Flue

⊗ 526-195	Steel	BF	Logs	Vermiculite	Nat. Gas	6.70	5.50	82%
⊗ 526-578	Steel	BF	Logs	Vermiculite	LPG	6.80	5.60	82%
⊗ 526-247	Steel	BF	Logs	Black Reeded	Nat Gas	6.70	5.50	82%
⊗ 526-681	Steel	BF	Logs	Black Reeded	LPG	6.80	5.60	82%
⊗ 526-286	Steel	BF	Logs	Brick Effect	Nat. Gas	6.70	5.50	82%
⊗ 526-694	Steel	BF	Logs	Brick Effect	LPG	6.80	5.60	82%
⊗ 526-325	Steel	BF	Logs	Black Glass	Nat. Gas	6.70	5.50	82%
⊗ 526-707	Steel	BF	Logs	Black Glass	LPG	6.80	5.60	82%

Gas Riva2 F670 - Accessories

926-001	Riva2 F670 Apex Stand
934-096	Riva2 670 Conventional Flue, Black Reeded Lining Set
934-103	Riva2 670 Conventional Flue, Vermiculite Lining Set
934-119	Riva2 670 Conventional Flue, Brick Effect Lining Set
934-174	Riva2 670 Conventional Flue, Black Glass Lining Set
934-127	Riva2 670 Balanced Flue, Black Reeded Lining Set
934-111	Riva2 670 Balanced Flue, Vermiculite Lining Set
934-137	Riva2 670 Balanced Flue, Brick Effect Lining Set
934-200	Riva2 670 Balanced Flue, Black Glass Lining Set
999-620	Remote System Mains Adaptor

Gas Riva2 F670 Glass & Steel Dimensions (mm)

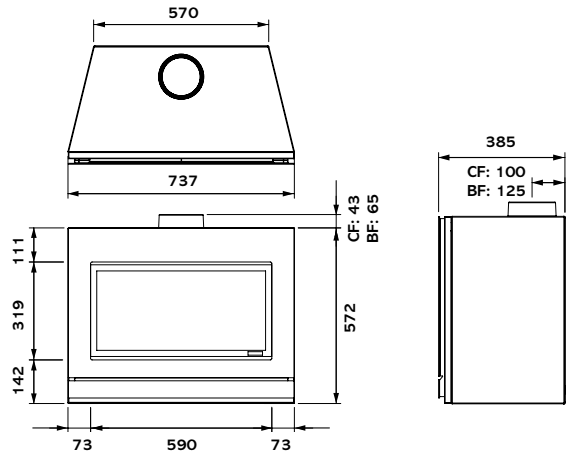

Gas Riva2 F670 Apex Stand Dimensions (mm)

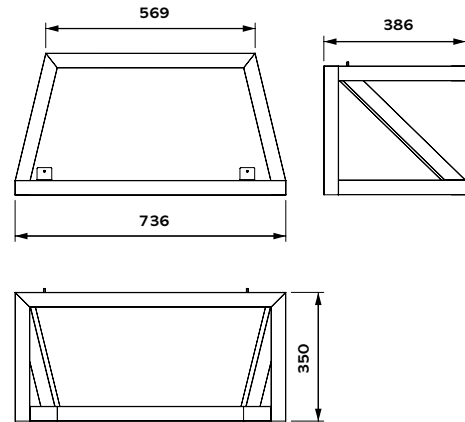

Recommended clearances between stove and other surfaces: top 9" (225mm), sides 6" (150mm), rear 2" (50mm).

The Gas Riva2 F670 stoves can also be placed on one of our ten Riva Stove Benches. Please see page 66 for further information.

Stove Flue Pipe

Balanced flue versions of the Gas Riva2 F670 Stoves must only use the 6" stainless steel or anthracite flue pipe. For the conventional flue version of the Gas Riva2 F670 Gazco recommends the use of 5" matt black or gloss enamelled stove pipe. The components usually required are:

Matt Black Flue Pipe	Product Code	Gloss Flue Pipe	Product Code
1' Straight pipe	4500	1' Straight pipe	4500GB
2' Straight pipe	4501	2' Straight pipe	4501GB
3' Straight pipe	4502	3' Straight pipe	4502GB
90° Long 'elbow' adaptor (9" projection)	4514	135° Bend	4512GB

Gas & Electric Riva Vision

Product Code	Model	CF/BF	Fuel Effect	Lining	Fuel Type	Flue Exit	Heat Input (kW)	Heat Output (kW)	Efficiency
Gas Riva Vision Small - Manual & Upgradeable Remote Options									
⊗ 526-013	Small	CF	Logs	Vermiculite	Nat. Gas	Rear	3.4	2.55	75%
⊗ 526-643	Small	CF	Logs	Vermiculite	LPG	Rear	3.2	2.40	75%
⊗ 526-021	Small	CF	Logs	Vermiculite	Nat. Gas	Top	3.4	2.55	75%
⊗ 526-656	Small	CF	Logs	Vermiculite	LPG	Top	3.2	2.40	75%
⊗ 526-046	Small	BF	Logs	Vermiculite	Nat. Gas	Rear	3.2	2.56	80%
⊗ 526-405	Small	BF	Logs	Vermiculite	LPG	Rear	3.2	2.56	80%

Gas Riva Vision Midi - Manual & Upgradeable Remote Options									
⊗ 526-065	Midi	CF	Logs	Vermiculite	Nat. Gas	Rear	4.55	3.41	75%
⊗ 526-417	Midi	CF	Logs	Vermiculite	LPG	Rear	4.35	3.26	75%
⊗ 526-077	Midi	CF	Logs	Vermiculite	Nat. Gas	Top	4.55	3.41	75%
⊗ 526-440	Midi	CF	Logs	Vermiculite	LPG	Top	4.35	3.26	75%
⊗ 526-100	Midi	BF	Logs	Vermiculite	Nat. Gas	Rear	4.3	3.44	80%
⊗ 526-471	Midi	BF	Logs	Vermiculite	LPG	Rear	4.3	3.44	80%
⊗ 526-109	Midi	BF	Logs	Vermiculite	Nat. Gas	Top	4.3	3.44	80%
⊗ 526-486	Midi	BF	Logs	Vermiculite	LPG	Top	4.3	3.44	80%

Gas Riva Vision Medium - Manual & Upgradeable Remote Options									
⊗ 526-122	Medium	CF	Logs	Vermiculite	Nat. Gas	Rear	6.6	4.95	75%
⊗ 526-515	Medium	CF	Logs	Vermiculite	LPG	Rear	6.7	5.03	75%
⊗ 526-137	Medium	CF	Logs	Vermiculite	Nat. Gas	Top	6.6	4.95	75%
⊗ 526-539	Medium	CF	Logs	Vermiculite	LPG	Top	6.7	5.03	75%
⊗ 526-155	Medium	BF	Logs	Vermiculite	Nat. Gas	Rear	6.6	5.54	84%
⊗ 526-580	Medium	BF	Logs	Vermiculite	LPG	Rear	6.6	5.54	84%
⊗ 526-176	Medium	BF	Logs	Vermiculite	Nat. Gas	Top	6.6	5.54	84%
⊗ 526-612	Medium	BF	Logs	Vermiculite	LPG	Top	6.6	5.54	84%

Gas Riva Vision Large - Thermostatic Control (Top exit only)									
⊗ 526-327	Large	CF	W. Stones	B.Enamel	Nat. Gas	Top	6.90	5.20	75%
⊗ 526-428	Large	CF	W. Stones	B.Enamel	LPG	Top	6.90	5.20	75%
⊗ 526-274	Large	CF	Logs	Vermiculite	Nat. Gas	Top	6.70	5.00	75%
⊗ 526-616	Large	CF	Logs	Vermiculite	LPG	Top	6.30	5.10	81%
⊗ 526-044	Large	CF	Logs	B.Reeded	Nat. Gas	Top	6.90	5.20	75%
⊗ 526-599	Large	CF	Logs	B.Reeded	LPG	Top	6.90	5.20	75%
⊗ 526-059	Large	BF	W. Stones	B.Enamel	Nat. Gas	Top	6.30	5.10	81%
⊗ 526-551	Large	BF	W. Stones	B.Enamel	LPG	Top	6.10	4.95	81%
⊗ 526-397	Large	BF	Logs	Vermiculite	Nat. Gas	Top	6.40	5.20	81%
⊗ 526-730	Large	BF	Logs	Vermiculite	LPG	Top	6.30	5.10	81%
⊗ 526-378	Large	BF	Logs	B.Reeded	Nat. Gas	Top	6.40	5.20	81%
⊗ 526-741	Large	BF	Logs	B.Reeded	LPG	Top	6.30	5.10	81%

Gas Riva Vision - Accessories

8455	Standard Upgradeable Remote Control for Riva Vision Small, Midi & Medium								
8456	Programmable Thermostatic Upgradeable Remote for Riva Vision Small, Midi & Medium								
923-797	Clear Glass fuel effect upgrade for Riva Vision Large only ◊								
923-746	Red Glass fuel effect upgrade for Riva Vision Large only ◊								
923-735	Black Glass fuel effect upgrade for Riva Vision Large only ◊								
923-517	Large Riva Vision Conventional Flue - Black Reeded Lining Set ‡								
923-607	Large Riva Vision Balanced Flue - Black Reeded Lining Set ‡								
999-620	Thermostatic system mains adaptor for Riva Vision Large only								

◊ Available as an upgrade to Riva Vision Large models with White Stone fuel bed

‡ Available for Riva Vision Large models with Log effect fuel bed

Electric Riva Vision with Remote Control

⊗ 634-680	Small	-	Logs	-	Electric	-	-	2.00	99%
⊗ 634-733	Midi	-	Logs	-	Electric	-	-	2.00	99%
⊗ 634-795	Medium	-	Logs	-	Electric	-	-	2.00	99%

The above information is to assist in your choice of a suitable Gazco stove. This is not intended to be all the information required to install your stove. This can be obtained from your local Gazco retailer or you can download the full installation instructions from the Gazco website at www.gazco.com

Gas Riva Vision Small, Midi & Medium Dimensions

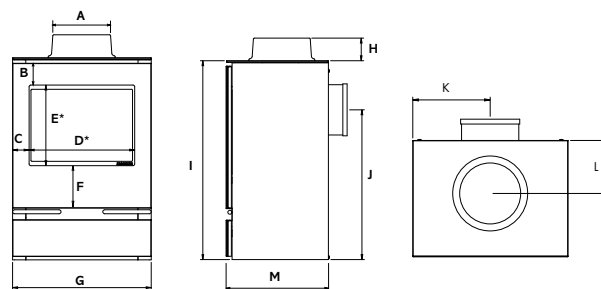

*Glass Viewing Area

Gas Riva Vision Small, Midi & Medium Dimensions (see letters on diagram)

All sizes in mm	A	B	C	D	E	F	G	H	I	J	K	L	M
Small CF	143	57	58	254	240	122	370	43	529	359	185	97	289
Small BF¹	N/A	57	58	254	240	122	370	N/A	529	379	185	N/A	289
Midi CF	143	65	50	316	241	127	415	43	605	436	207.5	96	311
Midi BF	173	65	50	316	241	127	415	69	605	456	207.5	142	311
Medium CF	143	77	64	408	274	150	535	43	677	487	268	100	353
Medium BF	173	77	64	408	274	150	535	69	677	538	268	139	353

¹Riva Vision Small Balanced flue is rear flue exit only

Electric Riva Vision Dimensions (see letters on diagram)

All sizes in mm	A	B	C	D	E	F	G	H	I	J	K	L	M
Small	N/A	57	58	254	240	122	370	N/A	555	N/A	N/A	N/A	299
Midi	N/A	65	50	316	241	127	415	N/A	604	N/A	N/A	N/A	320
Medium	N/A	77	64	408	274	152	535	N/A	676	N/A	N/A	N/A	363

Gas Riva Vision Large Dimensions

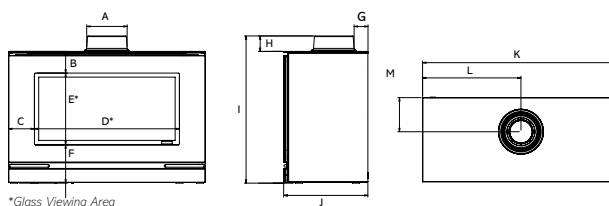

*Glass Viewing Area

Gas Riva Vision Large Dimensions (see letters on diagram)

All sizes in mm	A	B	C	D	E	F	G	H	I	J	K	L	M
Large CF	144	96	115	646	320	172	66	43	631	390	876	438	140
Large BF	173	97	115	646	320	171	62	69	656	375	876	438	152

Recommended clearances between stove and other surfaces: top 9" (225mm), sides 6" (150mm), rear 2" (50mm). The Gas Riva Vision Large has a top flue exit only.

The Gas Riva Vision stoves can also be placed on one of our ten Riva Stove Benches. Please see page 57 for further information.

Stove Flue Pipe

Balanced flue versions of the Gas Riva Visions must only use the 6" stainless steel or anthracite flue pipe. For the conventional flue version of the Gas Riva Vision Gazco recommends the use of 5" matt black or gloss enamelled stove pipe. The components usually required are:

Matt Black Flue Pipe	Product Code	Gloss Flue Pipe	Product Code
1' Straight pipe	4500	1' Straight pipe	4500GB
2' Straight pipe	4501	2' Straight pipe	4501GB
3' Straight pipe	4502	3' Straight pipe	4502GB
90° Long 'elbow' adaptor (9" projection)	4514	135° Bend	4512GB
Flue collar	8549		

Studio Freestanding Gas

The below information is to assist in your choice of a suitable Gazco stove. This is not intended to be all the information required to install your stove. This can be obtained from your local Gazco retailer or you can download the full installation instructions from the Gazco website at www.gazco.com

Studio 1 Freestanding

Product Code	Front Finish	CF/BF	Fuel Effect	Lining	Fuel Type	Heat Input (kW)	Heat Output (kW)	Efficiency
⊗ 508-007	Black	CF	Logs	Vermiculite	Nat. Gas	6.70	4.70	70%
⊗ 508-016	Black	CF	Logs	Black Reeded	Nat. Gas	6.70	4.70	70%
⊗ 508-405	Black	CF	Logs	Vermiculite	LPG	6.90	4.83	70%
⊗ 508-414	Black	CF	Logs	Black Reeded	LPG	6.90	4.83	70%
⊗ 508-025	White	CF	Logs	Vermiculite	Nat. Gas	6.70	4.70	70%
⊗ 508-034	White	CF	Logs	Black Reeded	Nat. Gas	6.70	4.70	70%
⊗ 508-423	White	CF	Logs	Vermiculite	LPG	6.90	4.83	70%
⊗ 508-441	White	CF	Logs	Black Reeded	LPG	6.90	4.83	70%

Studio 1 Freestanding - Log Effect, Balanced Flue

⊗ 508-044	Black	BF	Logs	Vermiculite	Nat. Gas	6.40	5.20	81%
⊗ 508-052	Black	BF	Logs	Black Reeded	Nat. Gas	6.40	5.20	81%
⊗ 508-450	Black	BF	Logs	Vermiculite	LPG	6.30	5.10	81%
⊗ 508-468	Black	BF	Logs	Black Reeded	LPG	6.30	5.10	81%
⊗ 508-061	White	BF	Logs	Vermiculite	Nat. Gas	6.40	5.20	81%
⊗ 508-070	White	BF	Logs	Black Reeded	Nat. Gas	6.40	5.20	81%
⊗ 508-672	White	BF	Logs	Vermiculite	LPG	6.30	5.10	81%
⊗ 508-594	White	BF	Logs	Black Reeded	LPG	6.30	5.10	81%

Studio 1 Freestanding - White Stones, Conventional Flue

⊗ 508-013	Black	CF	W. Stones	Enamel Black	Nat. Gas	6.90	4.85	70%
⊗ 508-536	Black	CF	W. Stones	Enamel Black	LPG	6.90	4.85	70%
⊗ 508-039	White	CF	W. Stones	Enamel Black	Nat. Gas	6.90	4.85	70%
⊗ 508-434	White	CF	W. Stones	Enamel Black	LPG	6.90	4.85	70%

Studio 1 Freestanding - White Stones, Balanced Flue

⊗ 508-065	Black	BF	W. Stones	Enamel Black	Nat. Gas	6.30	5.10	81%
⊗ 508-611	Black	BF	W. Stones	Enamel Black	LPG	6.10	4.95	81%
⊗ 508-091	White	BF	W. Stones	Enamel Black	Nat. Gas	6.30	5.10	81%
⊗ 508-664	White	BF	W. Stones	Enamel Black	LPG	6.10	4.95	81%

Plinth & Bench Mounting Choice (Required)

999-022	Studio 1 Freestanding Plinth - Black
999-035	Studio 1 Freestanding Plinth - White
999-101	Studio 1 Freestanding Bench - Black
999-114	Studio 1 Freestanding Bench - White

Accessories

923-797	Studio 1 Clear Glass Fuel Effect Upgrade (For White Stone Models only)
923-735	Studio 1 Black Glass Fuel Effect Upgrade (For White Stone Models only)
923-746	Studio 1 Red Glass Fuel Effect Upgrade (For White Stone Models only)
923-517	Studio 1 CF - Black Reeded Lining Set (For Log Effect Models only)
923-010	Studio 1 CF - Vermiculite Reeded Lining Set (For Log Effect Models only)
923-607	Studio 1 BF - Black Reeded Lining Set (For Log Effect Models only)
923-433	Studio 1 BF - Vermiculite Reeded Lining Set (For Log Effect Models only)
999-620	Remote System Mains Adaptor

Studio Freestanding Gas Dimensions (mm)

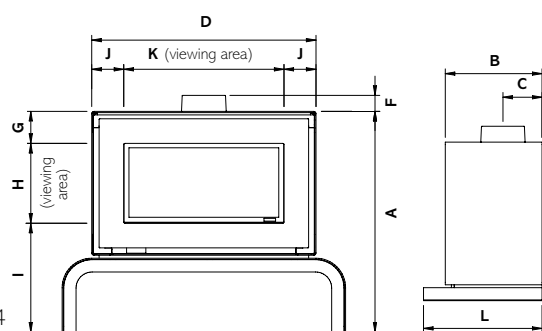

Studio 2 Freestanding

Product Code	Front Finish	CF/BF	Fuel Effect	Lining	Fuel Type	Heat Input (kW)	Heat Output (kW)	Efficiency
508-709	Black	CF	Logs	Vermiculite	Nat. Gas	8.50	6.65	78%
508-088	Black	CF	Logs	Black Reeded	Nat. Gas	8.50	6.65	78%
508-495	Black	CF	Logs	Vermiculite	LPG	8.80	6.85	78%
508-504	Black	CF	Logs	Black Reeded	LPG	8.80	6.85	78%
508-253	White	CF	Logs	Vermiculite	Nat. Gas	8.50	6.65	78%
508-266	White	CF	Logs	Black Reeded	Nat. Gas	8.50	6.65	78%
508-513	White	CF	Logs	Vermiculite	LPG	8.80	6.85	78%
508-522	White	CF	Logs	Black Reeded	LPG	8.80	6.85	78%

Studio 2 Freestanding - Log Effect, Balanced Flue

⊗ 508-115	Black	BF	Logs	Vermiculite	Nat. Gas	8.60	7.00	81%
⊗ 508-124	Black	BF	Logs	Black Reeded	Nat. Gas	8.60	7.00	81%
⊗ 508-540	Black	BF	Logs	Vermiculite	LPG	8.00	6.50	81%
⊗ 508-558	Black	BF	Logs	Black Reeded	LPG	8.00	6.50	81%
⊗ 508-133	White	BF	Logs	Vermiculite	Nat. Gas	8.60	7.00	81%
⊗ 508-142	White	BF	Logs	Black Reeded	Nat. Gas	8.60	7.00	81%
⊗ 508-567	White	BF	Logs	Vermiculite	LPG	8.00	6.50	81%
⊗ 508-585	White	BF	Logs	Black Reeded	LPG	8.00	6.50	81%

Studio 2 Freestanding - White Stones, Conventional Flue

508-104	Black	CF	W. Stones	Enamel Black	Nat. Gas	8.30	6.50	78%
508-473	Black	CF	W. Stones	Enamel Black	LPG	8.30	6.50	78%
508-292	White	CF	W. Stones	Enamel Black	Nat. Gas	8.30	6.50	78%
508-486	White	CF	W. Stones	Enamel Black	LPG	8.30	6.50	78%

Studio 2 Freestanding - White Stones, Balanced Flue

⊗ 508-130	Black	BF	W. Stones	Enamel Black	Nat. Gas	8.40	6.80	81%
⊗ 508-499	Black	BF	W. Stones	Enamel Black	LPG	7.30	5.92	81%
⊗ 508-156	White	BF	W. Stones	Enamel Black	Nat. Gas	8.40	6.80	81%
⊗ 508-525	White	BF	W. Stones	Enamel Black	LPG	7.30	5.92	81%

Plinth & Bench Mounting Choice (Required)

999-048	Studio 2 Freestanding Plinth - Black
999-087	Studio 2 Freestanding Plinth - White
999-127	Studio 2 Freestanding Bench - Black
999-166	Studio 2 Freestanding Bench - White

Accessories

923-751	Studio 2 Clear Glass Fuel Effect Upgrade (For White Stone Models only)
923-760	Studio 2 Black Glass Fuel Effect Upgrade (For White Stone Models only)
923-724	Studio 2 Red Glass Fuel Effect Upgrade (For White Stone Models only)
923-744	Studio 2 CF - Black Reeded Lining Set (For Log Effect Models only)
923-337	Studio 2 CF - Vermiculite Reeded Lining Set (For Log Effect Models only)
923-476	Studio 2 BF - Black Reeded Lining Set (For Log Effect Models only)
923-938	Studio 2 BF - Vermiculite Reeded Lining Set (For Log Effect Models only)
999-620	Remote System Mains Adaptor

All sizes in mm

	A	B	C	D	E	F	G	H	I	J	K	L
Studio 1 FS on Bench	896	396	CF: 148 BF: 160	910	1150	CF: 43 BF: 65	130	324	442	130	650	-
Studio 2 FS on Bench	896	396	CF: 148 BF: 160	1110	1350	CF: 43 BF: 65	130	324	442	130	850	-
Studio 1 FS on Plinth	649	396	CF: 148 BF: 160	910	1105	CF: 43 BF: 65	130	324	195	130	650	485
Studio 2 FS on Plinth	649	396	CF: 148 BF: 160	1110	1305	CF: 43 BF: 65	130	324	195	130	850	485

Recommended clearances between stove and other surfaces: top 9" (225mm), sides 6" (150mm), rear 2" (50mm).

Riva Stove Benches

These versatile steel benches are compatible with the Gas and Electric Riva Vision and Gas Riva2 F670 Stoves (page 38-47). With five widths and two heights, they offer infinitely greater design possibilities to accommodate your individual styling requirements.

Design Features

- Sturdy steel construction
- Choice of five widths and two heights
- Durable matt black finish
- Proportioned 60mm wide legs
- Allows for central or offset stove positioning

Product Code	Product	W (mm)	H (mm)	D (mm)
RVACLB45B	45 Low Riva bench	450	250	420
RVACB45B	45 High Riva bench	450	350	420
RVACLB100B	100 Low Riva bench	1000	250	420
RVACB100B	100 High Riva bench	1000	350	420
RVACLB120B	120 Low Riva bench	1200	250	420
RVACB120B	120 High Riva bench	1200	350	420
RVACLB140B	140 Low Riva bench	1400	250	420
RVACB140B	140 High Riva bench	1400	350	420
RVACLB180B	180 Low Riva bench	1800	250	465
RVACB180B	180 High Riva bench	1800	350	465



Gazco is a member of the Stovax Group which manufactures and distributes many other high quality fireplace products:



Gazco gratefully acknowledges the assistance of the following companies with photographic settings:

Furnishings and Ornaments:- www.furniturevillage.co.uk; www.romo.com; www.debenhams.com; www.eclectique.co.uk; www.theorangetree.co.uk; www.justshutters.co.uk; www.homebase.co.uk; www.lauraashley.com; www.faginsantiques.com; www.nestinteriors.com; www.stbridgetnurseryseries.co.uk; www.ashorejewellery.co.uk; www.johnlewis.com; www.veryvintagehire.co.uk; www.carpetright.co.uk **Wood Mantels:-** www.stovax.com **Stone Mantels:-** www.rudloe-stone.com; www.farmington.co.uk; www.bnspp.co.uk
Paintings:- www.easyart.com **Flooring:-** www.beachbros.co.uk; www.originalstyle.com; www.carpetright.com



Gas Huntingdon 30 in Ivory Enamel. Also shown: Georgian mantel in White from Stovax



Gazco Limited

Osprey Road, Sowton Industrial Estate, Exeter, Devon, England EX2 7JG

Tel: 01392 261999 Fax: 01392 444148

E-mail: info@gazco.com • www.gazco.com

A member of the Stovax Group

Paper sourced from sustainable forests and printed using vegetable based inks



To view & download our complete range of brochures, simply scan this code or visit www.gazco.com

Your Gazco stockist:

£3.00

